

**ALLEGAN COUNTY  
DRAIN COMMISSIONER**

**SITE DEVELOPMENT RULES**

**Procedures and Design Standards for Stormwater Management**



**Denise Medemar  
Allegan County Drain Commissioner  
113 Chestnut Street  
Allegan, MI 49010**

**March 2021**

**Published By:**

**Allegan County Drain Commissioner**

113 Chestnut Street  
Allegan, MI 49010  
269.673.0440

[www.allegancounty.org/drain](http://www.allegancounty.org/drain)

Denise Medemar – Drain Commissioner  
Carolynn Parnell – Chief Deputy  
Brent Scholten – Drain Maintenance Supervisor

**Prepared By:**

**Fishbeck, Inc.**

1515 Arboretum Drive SE  
Grand Rapids, MI 49546  
616.575.3824  
Project No. 140855

**In Collaboration With:**

**Macatawa Area Coordinating Council (MACC)**

301 Douglas Avenue  
Holland, MI 49424

**Ottawa County Water Resources Commissioner**

12220 Fillmore, Room 141  
West Olive, MI 49460

**Muskegon County Drain Commissioner**

Central Services Building  
141 East Apple Avenue  
Muskegon, MI 49442

**Fahey Schultz Burzych Rhodes PLC**

4151 Okemos Road  
Okemos, MI 48864

Funding provided in part by the MACC through the State of Michigan  
Stormwater, Asset Management and Wastewater (SAW) Grant for FY 2014

# Table of Contents

PART 1 – GENERAL PROVISIONS.....	1
I. Letter of Intent.....	1
II. Purpose.....	2
A. Compliance with State Land Division Statute.....	2
B. Compliance with State and Federal Stormwater Mandates.....	2
C. Preferred Stormwater Management Strategies.....	3
III. Authority.....	6
A. Land Division Act.....	6
B. Mobile Home Commission Act.....	6
C. Condominium Act.....	6
D. Drain Code.....	6
E. Review Authority Granted by Local Municipalities.....	6
F. Provisions for Requirements in Addition to Minimum Standards.....	6
IV. Applicability.....	7
A. Review Required.....	7
B. Exemptions.....	7
C. Redevelopment.....	7
V. Severability Clause.....	7
VI. Fees.....	8
PART 2 – PROCEDURES FOR PLAN SUBMISSION AND APPROVAL.....	9
I. Submission and Approval.....	9
A. Concept Review Meeting.....	9
B. Submission.....	9
C. Changes and Resubmission.....	10
D. Approval.....	10
E. Expiration of Approval.....	11
F. Revocation of Approval.....	11
G. Submission of Construction Record Drawings.....	11
II. Stormwater Drainage Requirements.....	12
A. Drainage Plan.....	12
B. Regional Stormwater Management Facility.....	13
C. Off-site Mitigation and Payment-in-lieu.....	13
D. Restrictive Covenants.....	14
E. Maintenance Plan and Agreement.....	17
III. Drains Under Jurisdiction of the Drain Commissioner.....	18
A. Responsibility for Stormwater System Ownership and Maintenance.....	18
B. Easements.....	18
C. Surety.....	20
D. Dedication Agreements.....	21
E. Construction.....	23
F. Permits for Work in County Drains.....	24
PART 3 – STORMWATER MANAGEMENT REQUIREMENTS.....	25

# Table of Contents

I.	Summary.....	25
II.	Standards.....	27
	A. Water Quality.....	27
	B. Channel Protection.....	28
	C. Flood Control.....	29
	D. Pretreatment.....	31
	E. Hot Spots.....	32
	F. Coldwater Streams.....	33
	G. Watershed Policy Statements.....	33
III.	Design Process.....	34
	A. Identify Sensitive Areas.....	34
	B. Select Source Controls.....	34
	C. Size Runoff Controls.....	34
	D. Confirm an Adequate Outlet.....	34
	E. Select Best Management Practices (BMPs).....	34
	PART 4 – STORMWATER DESIGN CRITERA.....	36
I.	Soils Investigation.....	36
	A. Qualifications.....	36
	B. Background Evaluation.....	36
	C. Test Pit/Soil Boring Requirements.....	36
	D. Highest Known Groundwater Elevation.....	37
	E. Field Permeability Testing.....	37
	F. Design Infiltration Rates.....	38
	G. Minimum Allowable Infiltration Rate.....	39
II.	Calculation Methodology.....	40
	A. Calculating Runoff.....	40
	B. Rainfall.....	46
	C. Calculating Storage Volumes and Release Rates.....	47
	D. Groundwater Mounding.....	51
	E. Computing Tools.....	51
	F. LGROW Design Spreadsheet.....	52
	PART 5 – BMP DESIGN CRITERIA.....	54
I.	Non-Structural Best Management Practices.....	54
	A. Minimal Disturbance Area.....	55
	B. Protect Natural Flow Pathways.....	56
	C. Protect Sensitive Areas.....	57
	D. Native Revegetation.....	58
	E. Stormwater Disconnect.....	59
II.	Structural Best Management Practices.....	60
	A. Storm Sewer.....	61
	B. Culvert or Bridge.....	64
	C. Open Channel.....	65
	D. Detention Basins.....	66
	E. Retention Basins.....	75

# Table of Contents

F. Sediment Forebay .....	81
G. Spill Containment Cell .....	82
H. Infiltration Practices .....	85
I. Bioretention/Rain Garden .....	90
J. Constructed Filter .....	94
K. Planter Box .....	97
L. Pervious Pavement .....	100
M. Capture Reuse .....	103
N. Vegetated Roof .....	105
O. Water Quality Device .....	106
P. Bioswale and Water Quality Swale .....	107
Q. Vegetated Swale .....	112
R. Vegetated Filter Strip .....	115
S. Level Spreader .....	119

## List of Tables

Table 1 – Minimum Required Stormwater Standards .....	26
Table 2 – Stormwater Hot Spots .....	33
Table 3 – Stormwater BMP Matrix .....	35
Table 4 – Minimum Number of Soil Tests Required .....	36
Table 5 – Determination of a Design Infiltration Rate .....	38
Table 6 – Design Infiltration Rates by USDA Soil Texture Class .....	38
Table 7 – Rational Method Runoff Coefficients (5- to 100-year rainfall frequencies) .....	40
Table 8 – Surface Retardants Coefficients .....	41
Table 9 – Curve Numbers (CNs) from TR-55 .....	43
Table 10 – Runoff Coefficients for Small Storm Hydrology Method .....	45
Table 11 – Rainfall Amounts (inches) .....	46
Table 12 – Manning’s Roughness Coefficients .....	62
Table 13 – Minimum and Maximum Slopes for Storm Sewers .....	62
Table 14 –Hydraulic Conductivities for Filter Media .....	95
Table 15 – Permanent Stabilization Treatment for Vegetated Swales .....	113

## List of Figures

Figure 1 – USDA Soil Textural Triangle .....	39
Figure 2 – Extended Detention Hydrograph .....	48
Figure 3 – Manning’s Roughness Coefficients for Vegetated Swales .....	112
Figure 4a – Filter Strip Length (Sandy soils with HSG A) .....	116
Figure 4b1 – Filter Strip Length (Sandy Loam soils with HSG B) .....	116
Figure 4b2 – Filter Strip Length (Loam, Silt-Loam soils with HSG B) .....	116
Figure 4c – Filter Strip Length (Sandy Clay Loam soils with HSG C) .....	117
Figure 4d – Filter Strip Length (Clay Loam, Silty Clay, Clay soils with HSG D) .....	117

## List of Appendices

Appendix 1	Application Packet
Appendix 2	Drain Forms
Appendix 3	County Drain Use Permits
Appendix 4	Watershed Policy Statements

# Table of Contents

## List of Abbreviations

### Acronyms

ASTM	American Society for Testing and Materials
BMP	Best Management Practice
CN	Curve Number
DEQ	Michigan Department of Environmental Quality (Michigan Department of Environment, Great Lakes and Energy as of April 7, 2019)
DNR	Michigan Department of Natural Resources
EPA	United States Environmental Protection Agency
GASB	Governmental Accounting Standards Board
GIS	Geographic Information System
GVMC	Grand Valley Metropolitan Council
HSG	Hydrologic Soil Group
LGROW	Lower Grand River Organization of Watersheds
LID	Low Impact Development
MACC	Macatawa Area Coordinating Council
MCL	Michigan Compiled Laws
MDOT	Michigan Department of Transportation
MS4	Municipal Separate Storm Sewer System
NAICS	North American Industry Classification System
NAVD 88	North American Vertical Datum of 1988
NJDEP	New Jersey Department of Environmental Protection
NOAA	National Oceanic and Atmospheric Administration
NPDES	National Pollutant Discharge Elimination System
NRCS	Natural Resources Conservation Service
RRD	Remediation and Redevelopment Division
PA	Public Acts of Michigan
PDF	Portable Document Format
SEMCOG	Southeast Michigan Council of Governments
TMDL	Total Maximum Daily Load
TR-55	Technical Release 55
TSS	Total Suspended Solids
USDA	United States Department of Agriculture
USGS	United States Geological Survey

### List of Units

ft ( ' )	feet
in ( " )	inches
ac	acre
cfs	cubic feet per second
cft	cubic feet
hr	hour
H:V	horizontal to vertical
in/hr	inches per hour
mg/L	milligrams per liter
min	minute

# Table of Contents

## Definitions

County	County of Allegan, State of Michigan.
Road Commission	The Allegan County Road Commission.
Design Engineer	The civil engineer who is a professional engineer licensed under Article 20 of the Occupational Code (Act 299, PA 1980) retained by the Proprietor to design the site plan for a plat or any other land development, including stormwater management and drainage.
Drain Commissioner	The Drain Commissioner of the County of Allegan, State of Michigan.
Health Department	The Allegan County Health Department.
Proprietor	As defined by the Land Division Act (Act 288, PA 1967), any person, landowner, firm, association, partnership, corporation, or combination of any of them that holds an ownership interest in land, and who submits a site plan for drainage review (may also be referred to as the Developer).
Register of Deeds	The Allegan County Register of Deeds.
Review Engineer	The engineer appointed by the Drain Commissioner to review the stormwater management and drainage elements of a plat or any other land development.

## I. LETTER OF INTENT

ALLEGAN COUNTY DRAIN COMMISSIONER  
Pursuant to Section 105 of Act 288  
Public Acts of Michigan (PA) of 1967, as amended  
and  
Section 402 of the Federal Clean Water Act, as amended  
Nonpoint Source Discharge Elimination System (NPDES)  
for Municipal Separate Storm Sewer Systems (MS4)

IT IS HEREBY ORDERED that the *Allegan County Drain Commissioner Site Development Rules*, promulgated pursuant to The Land Division Act, formerly the Subdivision Control Act (Section 105 of Act 288, PA 1967, as amended by Act 591, PA 1996), and pursuant to the NPDES MS4 permit for Allegan County, are hereby adopted and shall be followed in the processing of all subdivision plats, and all other private and public land developments, which impact established county or intercounty drains under the jurisdiction of the Drain Commissioner pursuant to the Michigan Drain Code (Act 40, PA 1956, as amended), or for which the Drain Commissioner provides support to other state or county agencies, and site plan review support for stormwater management to local units of government via resolution or ordinance.

Updates or revisions to these rules may be published from time-to-time as deemed necessary by the Drain Commissioner. Revisions to the standards affecting the MS4 permit requirements must be reviewed and approved by the Michigan Department of Environmental Quality (DEQ) if required by law.

A resolution to authorize the fee schedule set forth herein, pursuant to the authority granted in the Land Division Act, was adopted by the Allegan County Board of Commissioners on December 22, 2004.

IT IS HEREBY FURTHER ORDERED that the effective date of these rules shall be the **15th day of March, 2021**.



Denise Medemar  
Allegan County Drain Commissioner



## II. PURPOSE

This manual was produced to update and unify site plan review procedures within Allegan County. It is the purpose of these site development rules to establish a uniform set of minimum standards for the management of stormwater to be applied county-wide and meet the following objectives:

1. Ensure stormwater drainage systems are adequate to address stormwater management needs within a proposed development, and protect the drainage, property, and water rights of landowners outside of the proposed development.
2. Reduce flood damage due to development.
3. Minimize the degradation of existing watercourses.
4. Prevent an increase in nonpoint source pollution.
5. Maintain site hydrology to avoid detrimental changes in the balance between stormwater runoff, groundwater recharge, and evapotranspiration.

### A. Compliance with State Land Division Statute

The Land Division Act, formerly known as the Subdivision Control Act (Act 288, PA 1967, as amended by Act 591, PA 1996), requires the county drain commissioner to publish rules governing the internal drainage of proposed subdivisions and outlets for drainage. The rules in this manual are intended to assist land developers by providing uniform procedures to be followed in the processing of preliminary and final plats, construction drawings, and establishment of county drains and their branches within and without of these subdivisions.

### B. Compliance with State and Federal Stormwater Mandates

County drains located within an urbanized area defined by the United States Environmental Protection Agency (EPA) are considered MS4s. The County is required to obtain an individual NPDES MS4 permit under Section 402 of the Federal Clean Water Act, as amended, and under Water Resources Protection (Part 31, Act 451, PA 1994) of the Michigan Natural Resource and Environmental Protection Act, as amended. An application for an MS4 permit for the Holland urbanized area was submitted to the DEQ on April 1, 2016.

The MS4 permit requires the drain commissioner to adopt an ordinance or other regulatory mechanism to address post-construction stormwater runoff from new development and redevelopment projects, including preventing or minimizing water quality impacts. The Post-Construction Stormwater Runoff Program of the MS4 permit requires among other things:

1. A water quality performance standard to ensure specified reductions in total suspended solids.
2. A channel protection performance standard to address resource impairments resulting from increases in bankfull flow rates and volumes.
3. A review procedure for the evaluation of infiltration best management practices (BMPs) to meet water quality and channel protection standards in areas of soil or groundwater contamination.
4. Measures to address associated pollutants in identified "hot spots," which include land uses with the potential for significant pollutant loading that could result in the contamination of surface water or groundwater, including public water supplies.
5. A long-term operation and maintenance plan and agreement allowing for inspection, including a mechanism for tracking the transfer of operation and maintenance responsibility and compliance.

The minimum standards in this manual meet the Post-Construction Storm Water Runoff Program requirements for new and redevelopments set forth in the *State of Michigan National Pollutant Discharge Elimination System Permit Application for Discharge of Storm Water to Surface Waters of the State from a Municipal Separate Storm Sewer System* (DEQ, 2013, Rev 10/2014).

## TMDLs

The MS4 permit also requires identification and prioritization of actions to reduce pollutants in stormwater discharges to make progress in meeting Total Maximum Daily Load (TMDL) Water Quality Standards. TMDL water bodies in Allegan County are summarized below:

TMDL Waterbody	Pollutant	Year Approved*
Lake Allegan	Phosphorus	2001
Lake Macatawa	Phosphorus	2000

\*TMDL approved by EPA; list current as of 2016 and subject to change.

## C. Preferred Stormwater Management Strategies

### Alternatives for Channel Protection

An alternative approach using extended detention is allowed by the DEQ for the urbanized area within Allegan County when the full channel protection volume cannot be retained onsite, and offsite options are not available. These standards define the conditions under which the alternative approach will be approved for use. A flow chart outlining this process is shown on the following page. Specific requirements are provided in Part 3 section “Channel Protection.”

Off-site mitigation for channel protection is allowed where physical constraints of individual sites may preclude effective onsite treatment. Specific requirements are provided in Part 2 section “Off-site Mitigation.”

Payment-in-lieu for channel protection will only be allowed if a program is available by a municipality, or as set forth in a Watershed Policy Statement. Specific requirements are provided in Part 2 section “Payment-in-lieu.”

Limiting site conditions can be addressed using off-site mitigation or payment-in-lieu (offsite options), the alternative approach (onsite option), or a combination of these options as the Drain Commissioner sees fit, only if the use of all other onsite BMPs has been maximized.

### Low Impact Development

Onsite Low Impact Development (LID) is the preferred stormwater management strategy to meet the multiple objectives identified previously. LID uses the basic principle modeled after nature to manage rainfall where it lands. The outcome of LID is mimicking existing site hydrology by using design techniques to infiltrate, filter, store, evaporate and detain runoff close to its source. Many of these techniques incorporate the use of vegetation, and are collectively referred to as Green Infrastructure. A LID approach offers additional benefits in terms of increased property value and potential cost savings.<sup>1</sup> The size of stormwater storage facilities and infrastructure can often be reduced by incorporating LID principles into a site design up front.

The *Low Impact Development Manual for Michigan* (SEMCOG, 2008) was used to develop this manual. The standards in this manual incorporate LID principles into the design process and include design criteria for LID and small site BMPs.

<sup>1</sup> United States Environmental Protection Agency (December 2007). *Reducing Stormwater Costs through Low Impact Development (LID) Strategies and Practices*, EPA 841-F-07-006.

Lower Grand River Organization of Watersheds MS4 Stormwater Ordinance Committee  
 Alternative Approach Flow-Chart

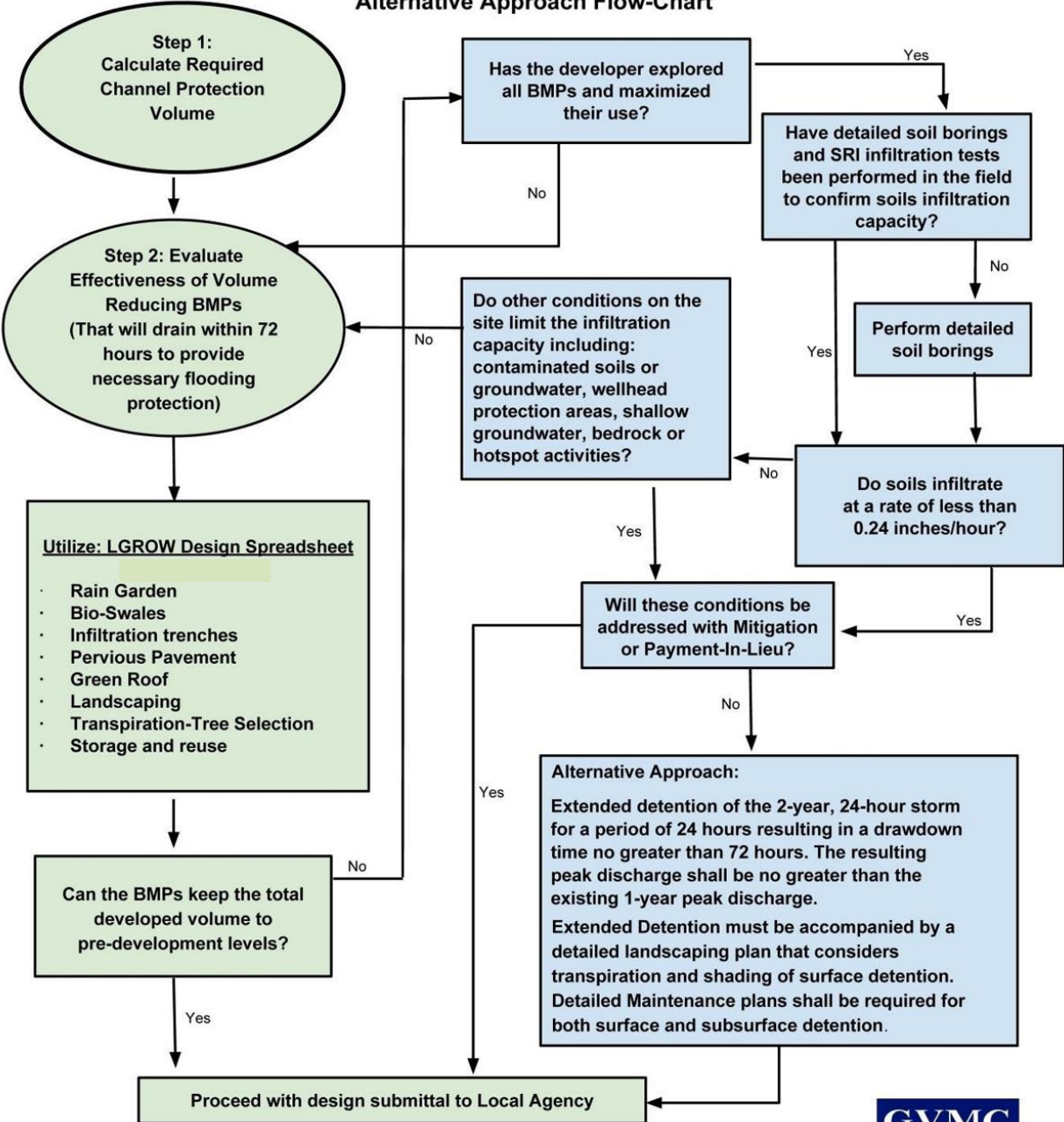

### Stormwater Management Preferred Approach Incorporates Low Impact Development (LID)



Traditional Parking Lot Design



Preferred: LID Parking Lot Design



Traditional "Big Box" Site Layout



Preferred: Equivalent LID Site Layout

### **III. AUTHORITY**

#### **A. Land Division Act**

All plats recorded with the Register of Deeds must conform to the Michigan Land Division Act, formerly known as the Subdivision Control Act (Act 288, PA 1967, as amended by Act 591, PA 1996). Under this Act, the county drain commissioner is responsible for ensuring that the stormwater drainage system of a subdivision is adequate to address stormwater management needs within the proposed subdivision and to protect downstream landowners, unless a governing body of a municipality in which the subdivision is situated has jurisdiction. The county drain commissioner has the authority, through the subdivision review process, to require that county drains, both inside and outside of a plat, be established or improved to the standards established by the county drain commissioner when necessary for the proper drainage of a proposed subdivision.

#### **B. Mobile Home Commission Act**

The standards set forth herein will be applied in review for plans for mobile home parks prepared under the Michigan Mobile Home Commission Act (Act 96, PA 1987.) The county drain commissioner has jurisdiction to review and approve outlet drainage, and interior drainage only if the streets or drains are dedicated to the public.

#### **C. Condominium Act**

The standards set forth herein will be applied in review of site condominium and regular condominium plans prepared under the Michigan Condominium Act (Act 59, PA 1978, as amended.) A notice of proposed action is required to be provided to the county drain commissioner.

#### **D. Drain Code**

The Michigan Drain Code (Act 40, PA 1956, as amended) provides the drain commissioner with jurisdiction over all drains established within a county. As such, the drain commissioner has an obligation to maintain the integrity of any given drain from all activities including development, which may directly impact the drain. All developments that discharge directly to an established county or intercounty drain shall conform to the requirements herein.

#### **E. Review Authority Granted by Local Municipalities**

All developments where review authority is granted to the Drain Commissioner by the local municipality (i.e. township, city, village) shall conform to the requirements herein. The Drain Commissioner's review of private drainage systems will focus on the discharge of stormwater offsite, but will include review of the internal drainage and the accommodation of surface water from upstream areas.

#### **F. Provisions for Requirements in Addition to Minimum Standards**

These rules provide minimum standards to be complied with by Proprietors and in no way limit the authority of the municipality in which the development is situated to adopt or publish and enforce higher standards as a condition of approval of the final plat or site plan. Proposed site plans shall complement any local stormwater master plans that may exist and/or comply with any ordinance in effect in the municipalities where the site development is located.

The Drain Commissioner reserves the right to determine site-specific requirements other than those herein, based upon review of the plans. Any deviations from these standards shall be subject to approval by the Drain Commissioner.

## IV. APPLICABILITY

### A. Review Required

These standards apply to private and public development and redevelopment projects in Allegan County. These standards also apply to County projects, including road projects. The following types of developments shall be subject to review under these standards:

1. Plats.
2. Mobile Home communities.
3. Site Condominiums with dedicated county or intercounty drains.
4. Sites discharging directly into a county drain.
5. All new development and redevelopment projects, including private, commercial and public projects that disturb at least one (1) acre or more, and projects less than one (1) acre that are part of a larger common plan of development or sale that would disturb one (1) acre or more, and discharge directly or indirectly into a regulated County MS4 (a county drain located within an urbanized area defined by the EPA under the NPDES program). For the purpose of these rules, all county drains located within an urbanized area are considered an MS4 even if they are Waters of the State.
6. Other private developments, including parcel splits requiring the modification or construction of a new public or private roadway, requiring site plan review at the local level, where stormwater and drainage review authority is granted to the Drain Commissioner by the municipality, or where review authority is retained by the municipality but the stormwater standards herein are referenced through ordinance.

### B. Exemptions

The following development activities are exempt from these standards:

1. Construction of individual single and two-family residential structures.
2. Additions or modifications to existing single and two-family residential structures and outbuildings.

Exemption from site plan review does not waive the responsibility of the Proprietor to determine the location of any drain or drain easement on the property.

### C. Redevelopment

By definition in the MS4 permit, redevelopment projects are those that change the existing site footprint, or offer new opportunities for stormwater control. Projects that disturb the underlying or surrounding soil, remove surrounding vegetation, or increase the area of impervious surface are considered redevelopment projects if they will alter the stormwater drainage characteristics of the site. For roadway projects, reconstruction of the subbase is considered redevelopment, whereas an overlay of the pavement surface is not.

Redevelopment and additions requiring site plan review at the local level shall comply with the current standards for the redeveloped or newly constructed portion of the site, except that the Drain Commissioner reserves the right to require the entire site be brought up to the current standards.

The last land use prior to the redevelopment shall be the condition of the site at the time of redevelopment. The Drain Commissioner may allow consideration for existing impervious surface that reverted or was converted to a pervious condition during vacancy.

## V. SEVERABILITY CLAUSE

If any part of these rules is found to be invalid, such invalidity shall not affect the remaining portions of the rules which can be given effect without the invalid portion, and to this end the rules are declared to be severable.

## VI. FEES

The fees for reviewing a plat or site development under these rules are set forth in the Schedule of Fees.

### Schedule of Fees

<b>Review</b>	
Plats and Site Condominiums	
County Administrative Fee	\$200.00
Preliminary Plat Fees	
1. Developments with 20 or less lots	\$200.00
2. Developments with 21 or more lots	\$10.00 per lot
Construction Plan Review Fee	
1. Open drains	\$0.25 per foot
2. Enclosed drains	\$0.60 per foot
3. Rear yard drainage within easements	\$0.25 per foot
4. Detention/retention basins (greatest distance across)	\$0.60 per foot
Miscellaneous Developments	
County Administrative Fee	\$50.00
Construction Plan Review	
1. Project less than 1 acre	\$350.00
2. Projects 1 to 10 acres	\$500.00
3. Projects 10 to 19 acres	\$750.00
4. Projects over 19 acres	\$1,000.00
<p>Submittal fees for administrative and engineering review shall be paid at the time plan submittal is made to the Drain Commissioner.</p> <p>Fees fund the review and plans by the Drain Commissioner's engineer. If the expense to review the proposed development exceeds the amount of fees collected, the Drain Commissioner shall charge additional fees to cover the actual cost.</p> <p>Recording fees incurred to register a document are the responsibility of the Proprietor.</p>	
<b>Dedication Agreements (433 Agreement)</b>	
Maintenance Fee (required by Michigan Drain Code)	Lesser of \$2,500 or 5% of construction
Surety for Work Completed after Final Plat Approval, or for Regional Stormwater Facility (Offsite Mitigation):	110% of uncompleted project
<p>Maintenance fee shall be paid prior to final plat approval and/or execution of the 433 Agreement. Surety shall be posted prior to final plat or site plan approval, and must be in the form of a cashier's check or irrevocable letter of credit. Recording fees incurred to register a document are the responsibility of the Proprietor.</p>	
<b>Drain Permits</b>	
County Drain Use Permit Fee	\$50
<p>A permit is required to locate a utility within a county drain easement, cross a county drain with utilities, roads, drives, etc., or connect to a county drain. Fees shall be paid with the permit application submittal prior to construction drawing approval.</p> <p>No fee is required for connecting stormwater discharges to a county drain; however, the Drain Commissioner reserves the right to charge a fee for connection of discharges other than stormwater runoff or tile drainage/footing drains.</p>	

## I. SUBMISSION AND APPROVAL

These procedures have been developed in the context of the plat requirements specified in the Land Division Act, which lays out a two-step submittal and approval process. A preliminary plat and final plat are required by statute.

For other types of developments, submittal of a condominium subdivision plan, preliminary plan, or site plan is required, which will typically culminate in a final set of construction drawings.

Developments located entirely within a municipality retaining stormwater review authority within their jurisdiction shall follow the procedures enacted by that municipality.

### A. Concept Review Meeting

The Land Division Act allows for a pre-application review meeting, which may be requested by the Proprietor for the purpose of an informal review of the concept plan for the preliminary plat. A site evaluation may also be requested. By statute, the review meeting shall take place not later than thirty (30) days after the request and concept plan are received.

A concept review meeting between the Proprietor and/or the Design Engineer, Drain Commissioner, Road Commission and local municipality is recommended prior to submittal of a site plan. The purpose of the concept review meeting is to initiate communication and provide uniform direction to the Proprietor to maximize efficiency in design and reduce costs.

The Proprietor is responsible for contacting the Drain Commissioner's office to request the meeting, submit the concept plan, and coordinate the location, date and time for the meeting with all parties involved. Information provided by the Proprietor in the concept plan shall include at a minimum the items on the Stormwater Review Checklist.

If the conceptual layout of the drainage plan is approved, the Proprietor may begin completing design plans and calculations for application submittal under these rules.

### B. Submission

The following submittals are required for Drain Commissioner review and approval prior to the start of any work on the proposed development requiring review under these rules. Soil borings and test pits, soil testing, vegetative cutting solely for land surveys, and normal maintenance shall not be considered a start of work under these rules. An application packet is included in **Appendix 1**.

#### Site Plan Review

1. Site Plan Review Application.
2. Stormwater Worksheet and calculations prepared by a professional engineer licensed in the State of Michigan.
3. Drawings. One (1) print and one (1) electronic PDF file containing the information on the Stormwater Review Checklist.
  - a. Preliminary plat or site plan: Prepared by a professional engineer or surveyor licensed in the State of Michigan.
  - b. Construction drawings: Sealed by a professional engineer licensed in the State of Michigan.
4. Applicable fee (refer to Part 1 section "Fees").
5. Other required submittals per these rules as applicable:
  - a. Submittal Checklist for Private Developments.
  - b. Submittal Checklist for County Drain Systems.



**Final Plat**

1. Evidence of preliminary plat approval. The preliminary plat must be approved by the municipal governing body in which the proposed development is located. Evidence of this approval shall be submitted to the Drain Commissioner's office with the final plat.
2. Final plat. The Land Division Act requires that one (1) true copy of the final plat be delivered to the Drain Commissioner for review. Final plats must be prepared in accordance with the requirements of the Land Division Act. Final plat mylars of the number and type are directed by the Michigan Department of Commerce. One (1) electronic file of the plat meeting County GIS digital submission requirements (refer to Stormwater Review Checklist) shall be submitted to the Drain Commissioner.
3. Construction Records. Acceptable construction record drawings and certification from the Design Engineer must be submitted along with the final plat. A Proprietor who desires to expedite the formal platting procedure shall enter into an agreement with the Drain Commissioner and post surety for faithful performance of the agreement (refer to Part 2 section "Surety").

**Staged Development**

Should the Proprietor plan to develop a given area but wish to begin with only a portion of the total area, the original preliminary plat or site plan shall include the proposed general layout for the entire area. The first phase of the development shall be clearly superimposed upon the overall plat or site plan in order to illustrate clearly the method of development that the Proprietor intends to follow. Each subsequent plat or site plan shall follow the same procedure until the entire area controlled by the Proprietor is developed.

Final acceptance by the Drain Commissioner of only one portion or phase of a development does not ensure final acceptance of any subsequent phases or the overall general plat or site plan for the entire area; nor does it mandate that the overall general plat or site plan be followed as originally proposed, if deviations or modifications acceptable to the Drain Commissioner are proposed.

**C. Changes and Resubmission**

Changes made without resubmission and approval may result in revocation of approval.

**Preliminary Plat**

Approval of the preliminary plat by the local governing body is required under the Land Division Act. Further, the approval of federal and state agencies may also be required. Should the approval of the local unit of government, federal, or state agencies require changes to the proposed layout, such changes shall be incorporated in a new layout and a new preliminary plat or site plan shall be resubmitted for review by the Drain Commissioner.

If the Proprietor finds it advantageous to make changes in the preliminary plat or site plan, they shall be incorporated in the plan and a new preliminary plat or site plan shall be resubmitted for approval. Resubmission is required even though the original layout may have already been approved.

**Construction Drawings**

If the Proprietor finds it advantageous or necessary to make design changes, or if the information given to the Drain Commissioner does not represent the conditions as they exist on the ground, and revisions are required as a result, such revisions shall be made by the Proprietor and the drawings resubmitted to the Drain Commissioner for approval.

**D. Approval**

Payment of all fees is prerequisite to approval (refer to Part 1 section "Fees").

**Preliminary Plat**

The Drain Commissioner within thirty (30) days after receipt of the preliminary plat will approve it, approve it subject to conditions, or reject it. If the preliminary plat is approved, the Drain Commissioner will note its approval on the copy to be returned to the Proprietor, or by letter if the Proprietor does not need the preliminary plat to be returned. If the preliminary plat is approved subject to conditions or rejected, the reasons for rejection and requirements for approval shall be given in writing to the Proprietor and each of the other officers and agencies to which the Proprietor was required to submit the preliminary plat.

**Construction Drawings**

The Land Division Act gives no time limit in which final construction plans must be reviewed. The Drain Commissioner will approve or reject construction drawings in writing within thirty (30) days of receipt of a complete submittal.

**Final Plat**

Final plat review will be completed by the Drain Commissioner's office within ten (10) days of submission by the Proprietor. If the plat is not acceptable, written notice of rejection and the reasons therefore will be given to the Proprietor and the clerk of the related municipality. Upon approval, the Drain Commissioner will sign the plat, and the plat will be executed.

**E. Expiration of Approval****Preliminary Plat**

If the Proprietor does not present the final plat to the Drain Commissioner for approval within a period of two (2) years after receiving approval of the tentative layout, it will be necessary to resubmit the layout for review. The preliminary layout is no longer valid and a new submittal is required.

**Construction Drawings**

Approval of construction drawings by the Drain Commissioner's office is valid for two (2) calendar years. If an extension beyond this period is needed, the Proprietor shall submit a written request to the Drain Commissioner for an extension. The Drain Commissioner may grant one-year extensions of the approval and may require updated or additional information, if needed. Should modifications be made to the drawings, a new review may be required subject to the appropriate fees.

**F. Revocation of Approval**

Any approval issued by the Drain Commissioner under these rules may be revoked or suspended for a violation of the conditions of approval, or a misrepresentation or failure to disclose relevant facts in the application submittal. The Drain Commissioner will provide the Proprietor written notice of any revocation of approval.

**G. Submission of Construction Record Drawings**

Construction record drawings (“as-builts”) shall be submitted to the Drain Commissioner for developments reviewed under these rules. A letter of certification by a professional engineer shall accompany the construction record drawings, or may be accepted in lieu of record drawings for some projects at the Drain Commissioner’s discretion. An Engineer’s Certification of Construction is included in **Appendix 2**.

One (1) print, one (1) electronic PDF file, and one (1) electronic file meeting County GIS digital submission requirements shall be submitted, and contain the information listed on the Stormwater Review Checklist.

Construction record drawings must be submitted prior to release of any review deposit. The Drain Commissioner will review construction record drawings for completeness, and respond with written comments or acceptance within thirty (30) days of submittal or resubmittal.

## II. STORMWATER DRAINAGE REQUIREMENTS

### A. Drainage Plan

#### Drainage Patterns

Proposed drainage for the development shall conform to existing watershed boundaries, natural drainage patterns within the site, or any established county drainage districts.

#### Staged Development

Each phase shall be self-sufficient from the standpoint of drainage.

#### Location of Stormwater Management Facilities

Stormwater management facilities within a development planned to have multiple lot owners shall be located on dedicated outlots, within road rights-of-way, or have separate easements granted to the entity responsible for operation and maintenance of the stormwater management system.

Parking lots, roadways, and pedestrian traffic areas shall not be flooded for use as stormwater detention.

#### Offsite Stormwater

Surface water flows from offsite land shall be routed around the development's onsite stormwater system whenever possible. An onsite detention basin shall not be used to pass this flow through the site. If water from offsite is directed through an onsite detention basin, the basin must either be designed as a regional stormwater management facility, or detain the existing offsite water to the same flood control standard as the site.

#### Stormwater Discharge

The rate, volume, concentration, or constitution of stormwater discharged from a site for the specified design storms shall not create adverse impacts to downstream property owners and watercourses. To that end, the following stormwater discharge requirements must be met for all sites:

1. Post-development discharge shall not exceed the capacity of the existing infrastructure or the existing discharge rate from the site.
2. Post-development discharge shall not cause adverse impact to offsite property due to concentrated runoff or ponded water of greater height, area, and duration.
3. Discharge shall not cause downstream erosion or sedimentation.
4. Discharge to groundwater shall not cause groundwater mounding sufficient to adversely impact structures or adjacent property.
5. Post-development discharge shall not cause impairments by the contribution of pollutants to surface water or groundwater.
6. Post-development discharge shall not cause impairments to coldwater streams due to thermal properties of the discharge.
7. For a downstream drainage system that is inadequate to handle any increase to the existing design discharge from the site development, it is the Proprietor's responsibility to:
  - a. Stabilize or upsize the existing conveyance system, or establish a county drain to provide the needed design level of flood protection.
  - b. Obtain flooding easements for increases in water levels determined to cause an adverse impact.
  - c. Provide additional onsite stormwater controls.

It is the Proprietor's obligation to meet these requirements. Should a stormwater system, as built, fail to comply, it is the Proprietor's responsibility to have constructed at their expense, any necessary additional and/or alternative stormwater management facilities, subject to the Drain Commissioner's review and approval.

## B. Regional Stormwater Management Facility

Regional stormwater management facilities are designed to serve multiple developments or parcels with more than one property owner at the time of development or redevelopment.

The Drain Commissioner may pursue projects within a drainage district through the petition process to construct facilities to serve a particular drainage area, or may approve facilities proposed to be constructed by individual Developers. Private facilities must have a written agreement between responsible parties with recorded easements to ensure operation and maintenance of the facility in perpetuity. Agreements must specify maximum allowable runoff coefficients for each parcel contributing to the facility.

The regional facility should be constructed first, prior to any development or redevelopment. Written approval is required from the Drain Commissioner if construction is to be delayed. Financial surety and temporary onsite measures must be provided until the facility is constructed.

## C. Off-site Mitigation and Payment-in-lieu

### Off-site Mitigation

Off-site mitigation refers to BMPs implemented at a location other than the proposed development or redevelopment, but within the same jurisdiction and watershed/sewershed as the original project to meet channel protection standards required by the MS4 permit. The watershed is the area represented by the DEQ, 10-digit Hydrologic Unit Code. The sewershed is the area where storm water is conveyed by an MS4 to a common outfall or point of discharge.

The Drain Commissioner also requires that the off-site mitigation is protective of the same watercourse or waterbody to which the site discharges, and is located downstream of the proposed development or redevelopment if possible.

### Payment-in-lieu

Payment-in-lieu refers to the Proprietor paying a fee to the Drain Commissioner, which is then applied towards a public stormwater management project that fulfills the channel protection and/or other stormwater requirements for the site. The stormwater management project may be either a regional stormwater management facility, a new BMP, or a retrofit to an existing BMP.

The Drain Commissioner will honor off-site mitigation or payment-in-lieu programs that a municipality may have in place under its own MS4 permit to the extent that undue impact does not result to associated county drains. Improvements to drains may be petitioned to mitigate undue impact.

The Drain Commissioner will only consider payment-in-lieu if the Drain Commissioner has a planned or constructed improvement project meeting the requirements for off-site mitigation as identified in a Watershed Policy Statement. The cost of payment-in-lieu will be determined on a case by case basis, and will represent the actual cost of implementing public water quality enhancements.

### Criteria

The determination to approve off-site mitigation or payment-in-lieu will be based on multiple criteria and not solely on the difficulty or cost of implementing BMPs on site. Conditions under which the option to move off site would become available may include:

1. Limited size of the lot outside of the building footprint to create the necessary infiltration capacity even with amended soils.
2. Soil instability as documented by a thorough geotechnical analysis.
3. A site use that is inconsistent with capture and reuse of stormwater.
4. Too much shade or other physical conditions that preclude adequate use of plants.

5. The potential water quality impact from the original project site and the benefits realized at the off-site location.

The Drain Commissioner may approve off-site mitigation or payment-in-lieu if the Developer demonstrates that site constraints preclude sufficient treatment and restoration of hydrology onsite, and the following minimum requirements are met:

1. Offset ratio. The offset ratio for the amount of storm water not managed onsite in relation to the amount of stormwater required to be mitigated at another site, or for which in-lieu payments will be made is as follows:
  - a. First Tier: Manage a minimum of 0.4 inches of storm water runoff onsite, and provide a 1 to 1.5 offset ratio for the remaining amount of storm water managed offsite.
  - b. Second Tier: If it completely infeasible to manage the minimum onsite, provide a 1 to 2 offset ratio for the amount of storm water managed offsite.
2. Schedule. Off-site mitigation shall be completed within 24 months after the start of the original site construction.
3. Assurances. Offset and in-lieu projects shall be preserved and maintained in perpetuity through the procedures and tracking system administered by the Drain Commissioner.

## D. Restrictive Covenants

For plats and site condominiums, a copy of restrictive covenants or master deed language related to drainage shall be provided to the Drain Commissioner along with construction drawings for approval. Covenants and deeds shall be recorded at the Register of Deeds prior to release of posted surety.

### Block Grading Plan

A block grading plan shall be incorporated in the restrictive covenants of the plat or master deed to ensure proper drainage of individual lots. In addition, the Proprietor shall provide a copy of the block grading plan to the Drain Commissioner and the municipality for their permanent files. The block grading plan shall include the Lowest Allowable Floor Elevation and Lowest Allowable Opening Elevation for each lot, and include the “basement type” for each lot (e.g. walkout, daylight, or standard basement) as indicated by the topography of each site and according to the approved design plans. The block grading plan shall state:

*The block grading plan shows the direction of flow for the surface drainage for all lots. It is the lot owner's responsibility to ensure that the final grading of the lot is in accordance with the block grading plan. During the final lot grading and landscaping, the owner shall take care to ensure that the installation of fences, planting, trees, and shrubs do not interfere with nor concentrate the flow of surface drainage. No changes will be made in the grading of any lot areas used for drainage which would later affect surface runoff drainage patterns without the prior written consent of the Drain Commissioner for all portions of the drainage system. Finish grading for home construction shall be completed in conformance with the master drainage plan for the development and in such a manner so as not to create the excessive ponding of stormwater on the sites within the development.*

### Minimum Floor and Opening Elevations

Minimum building floor and opening elevations shall be established to reduce the potential of structural damage and flooding of building interiors. A certification by the Design Engineer that the minimum floor and opening elevations do not pose a risk of flooding for up to the 100-year storm shall be provided for each development or phase of development prior to approval. Documentation to support allowable minimum floor and opening elevations shall be submitted with construction drawings.

Criteria for determining the Lowest Allowable Floor Elevation

1. Proximity to detention/retention facilities due to groundwater mounding (which may not be apparent until after construction).
2. Groundwater elevations from monitor wells, test pits and/or soil borings including any soil mottling noted in the soil profile.
3. Regional and cyclical groundwater levels available online.
4. Hydrogeologic studies and groundwater modeling.

Criteria for determining the Lowest Allowable Opening Elevation

1. Proximity to open drain or natural watercourse, pond or wetland and the 100-year flood elevation.
2. Proximity to detention/retention basin and design high water level.
3. Proximity to drainage swales and/or flood routes designed to convey the 100-year storm event runoff including overflows from detention/retention basins.
4. Proximity to an enclosed storm sewer system with open ends or catch basins that could surcharge during the 100-year storm event.
5. Type of building foundation (e.g. walkout, daylight, or standard basement) as dictated by the topography of each site.

Minimum floor and opening elevations shall be incorporated in the restrictive covenants of the plat or master deed, including bench mark references. It is the responsibility of the Proprietor to provide a sufficient number of bench marks (NAVD 88 datum) to use as a reference for establishment of minimum floor and opening elevations for all lots. Lots not impacted by high groundwater or potential flooding from a 100-year storm event as determined by the Design Engineer shall be so noted as well. The restrictive covenant shall state:

*The lowest allowable floor elevations are set at 2-foot or more above the highest known ground water elevation. The lowest allowable floor and/or opening elevations are set 1-foot or more above the 100-year floodplain or design high water level of the stormwater system. These elevations are set to reduce the risk of structural damage and the flooding of building interiors. A waiver from the set elevations may be granted by the Drain Commissioner following receipt of a certification from a professional engineer or surveyor licensed in the State of Michigan demonstrating that the proposed elevation does not pose a risk of flooding. Minimum building floor and opening elevations and bench mark locations and elevations are indicated on the Block Grading Plan.*

**Footing Drains and Sump Pumps**

Where footing drains and sump pumps are required or utilized, a stormwater lateral shall be provided for each parcel at the time of construction. Provide direction in the restrictive covenants of the plat or condominium master deed for footing drain and sump pump outlets. If proposed to be directed to the storm sewer system, the restrictive covenant shall state:

*Water from such sources as eave troughs and footing drains shall be directed to laterals provided for the lots. Water from footing drains shall be discharged to the lateral via a sump pump with check valve system, or a gravity system with a double flap gate valve for backflow prevention. If no lateral is provided, the lot owner shall discharge said water in such a manner as to not impact neighboring land or public streets.*

*Floor drains, laundry facilities or other similar features shall not be connected to a footing drain or sump pump system discharging to footing laterals and the storm sewer system. Laundry facilities and sewage lift pumps must discharge into the sanitary sewage disposal system.*

**Easements for Rear or Side Yard and Surface Drainage**

Private easements for enclosed yard drains and surface drainage are for the benefit of upland lots within the development or upland sites that currently drain across the proposed plat or site. Language shall be included within the restrictive covenants of the plat or condominium master deed that clearly notifies property owners of the location and purpose of private easements for rear or side yard and surface drainage, as well as restrictions on use or modification of these areas. A separate, recordable easement form is not required. The restrictive covenant shall state:

*Private easements for rear, side yard and surface drainage are for the benefit of upland lots within the subdivision and any improper construction, development, or grading that occurs within these easements will interfere with the drainage rights of those upland lots. Private easements for surface drainage are for the continuous passage of surface water and each lot owner will be responsible for maintaining the surface drainage system across their property. No construction is permitted within a private easement for rear, side yard and surface drainage. This includes fences, swimming pools, sheds, garages, patios, decks, or any other permanent structure or landscaping features. No dumping of grass clippings, leaves, brush or other refuse is allowed within a drainage easement. These items obstruct drainage, restrict flow and plug culverts. This can lead to higher maintenance costs and cause flooding situations.*

*Silt fence shall remain in place along the rear yard easement boundary until the lot has been final graded for landscaping and has established growth. Only the portion of silt fence on a lot that has been developed and that has adequate ground cover may be removed.*

**Soil Erosion and Sedimentation Control Permits**

It is the responsibility of the Proprietor to contact the Health Department (County Enforcing Agency) to determine which lots if any need a permit for Soil Erosion and Sedimentation Control (Part 91, Act 451, PA 1994). The restrictive covenant shall state:

*Each individual lot owner will be responsible for the erosion control measures necessary on their lot to keep loose soil from their construction activities out of the street, catch basins, and off of adjacent property. If any sedimentation in the street, catch basins, or adjacent lots results from construction for a particular site, it is the responsibility of that lot owner to remove the sediment and restore the lot to prevent further erosion. This applies to ALL lot owners.*

*A Soil Erosion and Sedimentation Control Permit must be obtained from the Allegan County Health Department prior to excavation for lots \_\_\_\_\_ through \_\_\_\_\_. All conditions set forth by permit shall be met throughout construction activity until permit is allowed to expire.*

**Responsibility for Maintenance of Open Water Bodies**

The restrictive covenant shall state:

*Lot owners are responsible for the management and maintenance of open water bodies for aesthetics, aquatic habitat, recreation and water quality, including liability and costs.*

## **E. Maintenance Plan and Agreement**

Developments with a privately-owned stormwater system in an urbanized area: A legally binding maintenance agreement between the Proprietor and the municipality is required before approval is granted for sites that disturb 1 acre or more and discharge into a municipality or County MS4. The maintenance agreement must include a maintenance plan and schedule, and require tracking of compliance. Contact the municipality for necessary forms, documents and compliance process. Verify with the municipality if a maintenance agreement will be required for all developments requiring stormwater review and located in the urbanized area, regardless of size.

Developments with a privately-owned stormwater system in a non-urbanized area: Verify with the municipality if a maintenance agreement will be required, and obtain necessary forms from the municipality.

A copy of the recorded maintenance agreement must be presented to the Drain Commissioner prior to construction drawing approval and release of any review deposit.



### III. DRAINS UNDER JURISDICTION OF THE DRAIN COMMISSIONER

#### A. Responsibility for Stormwater System Ownership and Maintenance

The Drain Commissioner will assume ownership of the following stormwater systems unless a municipality having jurisdiction accepts ownership.

##### Plats

Plats shall be established as county drains under the jurisdiction of the Drain Commissioner.

##### Other Developments

Site condominiums and other multi-lot developments with public roads shall be established as county drains under the jurisdiction of the Drain Commissioner.

The Drain Commissioner may accept jurisdiction over other multi-lot developments with private roads when a single private entity with responsibility for operation and maintenance does not exist.

##### Roadside Ditches

In general, the Drain Commissioner will not accept responsibility for roadside ditches. The Road Commission maintains these if located within the right-of-way of a public road. When required by the Road Commission, roadside ditches shall be established as county drain.

##### Maintenance by Drain Commissioner

The Drain Commissioner shall be responsible for maintenance of all established county drains, including stormwater BMPs dedicated as part of the county drain system. The costs for maintenance shall be assessed to the drainage district under the provisions of the Michigan Drain Code (Act 40, PA 1956).

The Drain Commissioner will not accept ownership and maintenance of any decentralized stormwater BMPs (e.g. rain barrels for individual houses, green roofs, and pervious pavement) as part of the county drain system. All portions of a county drain system must have dedicated easements.

##### Maintenance Plan

A maintenance plan must be prepared by the Proprietor and delivered to the Drain Commissioner with the dedication agreement documents. A maintenance plan template is included in **Appendix 2**.

##### Maintenance Agreement

A legally binding maintenance agreement between the land owner and the Drain Commissioner shall be submitted by property owner associations or corporate entities that desire to perform routine maintenance on the drainage system internal to the plat or development, which is established as a county drain. The maintenance plan shall be included with the executed maintenance agreement and recorded with the 433 Agreement. A sample maintenance agreement is included in **Appendix 2**.

#### B. Easements

##### Existing Easements

The liber and page (or document number) reference of all recorded easements shall be shown on final plats and construction drawings. Drainage easements obtained prior to 1956 were not required by statute to be recorded. Therefore, it may be necessary to check the permanent record of the Drain Commissioner's office to see if a drain easement is in existence on the subject property. Existing county drain easements (or release of rights-of-way) shall be indicated on the plans and designated with the name of the drain.

## Proposed Easements

An easement, not land ownership, is the approved method of providing access to, and protection of, public storm drainage facilities. Transfer of land ownership to an established drainage district is not allowed unless permitted in writing by the Drain Commissioner or other applicable authorities. Sample easement forms and agreements are included in **Appendix 2**.

### Within a Plat or Multi-Lot Site Development

All established county drains located within the plat or multi-lot site development, shall have granted easements. Private (exclusive) easements for drainage shall be granted to the appropriate drainage district and must be shown on the final plat or site plan. Related easement language shall be depicted on final plats and/or Exhibit B condominium drawings as follows:

*Easement for [Drainage] [Flooding] [Name of BMP] to the \_\_\_\_\_ Drain Drainage District.*

Separate, recordable easements must be provided in a form acceptable to the Drain Commissioner. Recordable drainage easements shall be submitted to the Drain Commissioner prior to construction drawing approval and recorded prior to release of surety or final plat approval and the sale of any lots which are to be encumbered by easements. If lots are sold prior to the Proprietor releasing an easement to the drainage district, the Proprietor shall obtain all necessary easements on said lots for completion of the project. Any lots sold on land contract must have the signature of both land contract vendor and vendee on the easement.

### Outside the Plat or Site Development

Private (exclusive) easements shall be required downstream of a plat or site development when the discharge is to a watercourse or an open or enclosed drainage way that requires improvements and maintenance to continue to serve as a viable outlet for the plat or site development. Recordable drain easements shall be submitted to the Drain Commissioner prior to construction drawing approval and recorded prior to release of surety. Easements will not be required through public rights-of-way (e.g. county roads).

### Flooding Easements

When concentrated stormwater is proposed to be discharged over, onto, or across private property (other than that owned by the Proprietor), and no watercourse or drainage way exists or is proposed to be constructed, an agreement between the owners must be executed relieving the drainage district of any and all responsibility for damage that might occur. Such an agreement shall be submitted to the Drain Commissioner prior to construction drawing approval and recorded prior to release of surety.

## Easement Width

Easements shall be situated in such a way as to allow maximum maintenance access (for example, by offsetting them from the drain centerline if required). Minimum easement widths for new stormwater systems shall conform to the following:

Open Channels and Watercourses. Open channels shall have a minimum of 15 feet on each side of the top of bank and a total minimum width of 50 feet.

Open Swales. Open swales shall have a total minimum width of 30 feet.

Enclosed Drains. Easement widths for pipes shall conform to the following:

Depth to Invert (feet)	Easement Width (feet)
0-7	30
7.1-12	40
12.1-17	50
>17	60

Detention and Retention (Infiltration) Basins. A minimum of 15 feet of open space outside the high water level and around the perimeter of a public detention/retention basin, and an easement over the temporary spoil disposal area must be granted to access and maintain the facility. Ingress and egress easements shall also be provided. For basins located adjacent to county drains, a minimum of 15 feet open, flat space between the basin and the county drain must be granted as a drainage easement for access and maintenance of both.

Other Stormwater BMPs. A minimum of 10 feet around the perimeter of stormwater BMPs (e.g. bioswale/rain garden, infiltration trench) must be granted to access and maintain the BMP.

Generally, the above widths shall govern; however, if the Review Engineer determines that additional easement width is required for proper construction, or because of special circumstances, such facts shall be made known to the Proprietor upon review by the Review Engineer. Exceptions to the above requirements may be made only at the discretion of the Drain Commissioner.

## C. Surety

The Proprietor shall post a performance surety prior to construction drawing approval.

The performance surety shall consist of a cash deposit, a certified check or an irrevocable letter of credit drawn on a bank licensed in the State of Michigan in an amount equal to 110% of the uncompleted portion of the project, or \$10,000, whichever is greater.

Valid existing contracts for construction of the stormwater management system and soil erosion control measures executed between the Proprietor and Proprietor's contractor shall be the basis for establishing the portion of the contract to be covered by surety.

In the event the Proprietor has not contracted for the construction of the stormwater management system (Proprietor is the contractor), the Design Engineer shall estimate the cost of said construction. The estimate of cost, as reviewed and approved by the Drain Commissioner, shall be the basis for the amount of surety.

### Rebate

A rebate to the Proprietor may be made as the work progresses with approval by the Drain Commissioner. The amount of the rebate will be equal to the cost of the completed work minus a 10% retainage. In no case shall the surety amount be reduced to less than \$10,000.

### Release of Surety

Upon final inspection, completion of all punch list items, receipt of acceptable construction record drawings and certification from the Design Engineer, the Drain Commissioner will execute an agreement granting final approval of the plat and/or final acceptance of the county drain and shall subsequently release the balance of any surety deposit to the Proprietor. A sample Agreement for Drain Commissioner Approval of Development Infrastructure is included in **Appendix 2**.

If the Proprietor does not complete the approved drainage improvements as agreed, the Drain Commissioner will draw on the surety and proceed to fulfill the Proprietor's obligation at such time and in such manner as the Drain Commissioner may determine appropriate.

## D. Dedication Agreements

Developments proposed to have public drains must submit a completed Dedication Agreement. Two methods for establishing and dedicating drainage facilities are provided for by the Michigan Drain Code. Rules developed by the Drain Commissioner for each method are similar.

### Section 433 Agreement

Section 433 of the Michigan Drain Code addresses enlargement of existing drainage districts and creation of new districts where none previously existed. A formal agreement is required between the Proprietor and the Drain Commissioner or intercounty drainage board on behalf of the affected drainage district. Owners of lands not owned by the Proprietor, who will be included in the drainage district, must also sign the agreement. The property of any adjoining landowner who refuses to sign cannot be included in the drainage district for assessment purposes. However, the Proprietor must accommodate surface and subsurface runoff from adjoining properties.

### Submittals

1. Agreement. The Proprietor and all parties having legal interest in the plat or development, as well as adjoining landowners, whose properties will be included in the enlarged or new drainage district, shall enter into a formal agreement dedicating drainage facilities therein for public use. The agreement form will be completed by the Proprietor in coordination with the Drain Commissioner and stipulate conditions of transfer and responsibilities of parties. Sample Section 433 Agreement forms are included in **Appendix 2**. The Drain Commissioner will determine which agreement form will be necessary. The 433 Agreement shall be signed by an authorized representative of the Proprietor and Drain Commissioner and be submitted for recording at the Register of Deeds prior to final plat approval and the sale of any lots in a plat or units in a site condominium. If property is sold on a land contract, both land contract vendor and vendee must sign the agreement. If more than one individual, corporation, partnership, or limited liability company has interest in the property, duly authorized representatives of each shall sign the 433 Agreement. Proprietor shall obtain on the 433 Agreement the signatures of all landowners or unit owners to whom lots are sold, if any.
2. Legal Descriptions.
  - a. Route and Course. The Design Engineer shall provide centerline descriptions for each drain or branch to be dedicated.
  - b. Drainage District. The Design Engineer shall provide a shape file of the drainage district boundary meeting County GIS digital submission requirements (refer to Stormwater Review Checklist), and a description of the contributing drainage district benefiting from such improvements. One (1) electronic PDF file, and one (1) print of a 24-inch by 36-inch drainage district map showing the drainage district boundary line, route & course of the drain, roads, lot and parcel lines with numbering, townships and sections, and other pertinent information shall be required. The Drain Commissioner may also require that adjoining drainage district boundaries changed by the dedication be described in their entirety for amending documents pertaining to those drains.
3. Certification. The Design Engineer shall include a sealed and dated statement attesting that (a) lands to be added to a drainage district naturally drain into the area served by the existing drain or that the existing drain is the only reasonably available outlet and attesting to the adequacy of existing receiving drains, or (b) that the outlet for the existing drain is the only reasonably available outlet and attesting to the adequacy of the outlet. An acceptable certification form is included in **Appendix 2**.
4. Specifications for construction.
5. As-builts, if not submitted with the Final Plat documents
6. A check payable to the Allegan County Register of Deeds for all recording fees.

7. Copy of the Master Deed. A copy of the 433 Agreement shall be attached to the Master Deed, and the Master Deed shall state:

\_\_\_\_\_ DRAIN DRAINAGE DISTRICT: Attached as Exhibit \_\_ is an Agreement establishing the \_\_\_\_\_ Drain Drainage District pursuant to Section 433 or Act No. 40 of the Public Acts of 1956 as amended. A copy of the 433 Agreement is recorded in the Allegan County Register of Deeds at Liber \_\_\_\_ Page \_\_\_\_.

When a 433 Agreement is accompanied by a maintenance agreement, the master deed shall also state:

Attached as exhibit \_\_\_\_ is a maintenance agreement outlining the maintenance responsibilities of the Association for the Drain. A copy of the maintenance agreement is recorded in the Allegan County Register of Deeds at Liber \_\_\_\_ Page \_\_\_\_.

*Note:* Exhibit A is typically by-laws and Exhibit B is typically condominium plans.

### Maintenance Fee

The Michigan Drain Code requires that any person dedicating a drain for public use shall provide funding for initial maintenance operations. Contribution is calculated by taking the lesser amount of \$2,500 or 5% of the cost of constructing the drain and its appurtenances. These funds shall be submitted to the Drain Commissioner prior to final plat approval and/or execution of the 433 Agreement. The funds are deposited in the account set up for the subject drain and are not refundable.

The \$2,500 fee is based on a stormwater system consisting solely of gravity components. Systems with non-gravity components are subject to fees above and beyond \$2,500.

### **Section 425 Application and Petition**

Section 425 of the Michigan Drain Code addresses the addition of branch drains to serve lands entirely within an existing drainage district and the enclosure or tiling of an existing drain. A Section 425 Agreement is required when a Proprietor wishes to relocate, improve and/or enclose a county drain on their own property at their expense. The Proprietor must petition the Drain Commissioner or intercounty drainage board for permission to construct or improve the additional drainage for public use.

### Submittals

1. The Drain Commissioner's legal counsel will draft the agreement with the Proprietor responsible for all costs. A sample agreement is included in **Appendix 2**.
2. Legal Descriptions. The Design Engineer or surveyor shall provide the centerline (route & course) descriptions for the branch drain or extension.
3. Certification. The Design Engineer shall include a sealed and dated statement attesting to the adequacy of existing receiving drains. An acceptable certification form is included in **Appendix 2**.
4. Specifications for construction.

## E. Construction

### Documentation of Value

Governmental accounting standards (GASB Statement 34) require the County to report the value of their drain infrastructure. The Proprietor shall submit documentation relative to the contract covering the work to be performed including the cost of construction with an itemized breakdown.

### Preconstruction Meeting

The Drain Commissioner may request a preconstruction meeting be held with all involved parties.

### Inspections

All fees for construction observation, quality assurance testing, and materials testing shall be paid for by the Proprietor.

#### By Proprietor

Upon request of the Drain Commissioner, the Proprietor shall retain a qualified inspector, supervised by the Design Engineer, to perform construction inspection of storm drains and appurtenances that will be the responsibility of the Drain Commissioner to operate and maintain to assure construction according to Drain Commissioner approved plans. Inspection activities shall be documented by written daily reports acceptable to the Drain Commissioner. Daily inspection reports shall be bound and submitted to the Drain Commissioner for review prior to final acceptance.

#### By Drain Commissioner

The Drain Commissioner may employ an inspector on behalf of the drainage district should it appear that the installation fails to meet minimum requirements. Spot inspections by the Review Engineer are to verify the proper construction of the drainage system. Inspection by the Drain Commissioner or the Review Engineer shall not relieve the Design Engineer or the municipal engineer of their obligations.

#### Final Inspection

The Drain Commissioner will complete a final inspection jointly with the Road Commission. Subsequent inspection may be required if deficiencies exist. The Drain Commissioner will issue a letter to the Proprietor upon final acceptance.

### Post-construction Certification

A letter of certification from the Design Engineer shall be submitted to the Drain Commissioner certifying construction of the county or intercounty drains in accordance with the approved construction drawings. An acceptable certification form is included in **Appendix 2**.

### Construction Record Drawings (“As-builts”)

Construction record drawings shall be submitted by the Proprietor to the Drain Commissioner in accordance with the submission requirements (refer to Part 2 section “Submission of Construction Record Drawings”).

If ownership of an existing storm sewer system is being transferred to the Drain Commissioner, construction record drawings must be accompanied by recent video documentation of the storm sewer that has been reviewed and accepted by a professional engineer licensed in the State of Michigan.

## F. Permits for Work in County Drains

Refer to Part 1 section “Fees” for Drain Use Permit fees. Sample applications, checklists and permits are included in **Appendix 3**.

### **Utilities**

If any utilities are to be located within the drainage easement of the proposed development, the Design Engineer shall present plans detailing such utilities to the Drain Commissioner for approval as to location. Utility plans shall be presented at the same time as construction drawings so that all details of construction and location may be checked and properly oriented with each other.

### **Encroachments**

Permission is required to place an encroachment within an existing drain easement.

### **Crossings and Maintenance**

A permit is required for maintenance to a county drain including installation of crossings, and shall be presented at the same time as construction drawings.

### **Modifications**

Agreements for modification (deepening, widening, straightening, relocating), tiling or adding a branch or extension to a county drain shall follow the procedures under “Section 425 Application and Petition.”

### **Connection**

A permit shall be obtained from the Drain Commissioner prior to connecting to any open or enclosed county drain and shall be presented at the same time as construction drawings.

### Footing Drains

Whenever building footing drains are required or utilized, footing drain leads shall be provided from a drainage structure (to the greatest extent practical) to service each lot. The Proprietor shall also provide a marker or monument indicating the location of the footing drain lateral access point.

### Floor Drains

Floor drains shall be connected to the sanitary sewer system.

## I. SUMMARY

The following stormwater management requirements comply with the County NPDES MS4 permit and shall apply to all new and redevelopments in Allegan County:

1. Protection. The design process shall begin by identifying environmentally sensitive areas located on the site and laying out the site to maximize protection of the sensitive areas.
2. Source Controls. Non-structural BMPs shall be used for protection of environmental sensitive areas on the site, and to reduce the amount of stormwater runoff.
3. Runoff Controls. Stormwater runoff shall be managed onsite using structural BMPs to protect both water resources and real property. Minimum stormwater standards are summarized in [Table 1](#). Higher standards may be required for sites that discharge to areas with known issues.
4. Watershed Policy Statements. Specific stormwater management policies (if any) established for identified watersheds or protection areas must be met in addition to these minimum standards.
5. Offsite Stormwater Management Options. Regional stormwater management facilities may be allowed where site constraints preclude effective onsite treatment of stormwater. Off-site mitigation and payment-in-lieu programs (if available) may be approved to meet channel protection standards.
6. Adequate Outlet. The design maximum release rate, volume or concentration of stormwater discharged from a site shall not exceed the capacity of the downstream stormwater infrastructure or cause impairment to the offsite receiving area.
7. BMP Design. BMPs must be designed to meet the minimum criteria provided. BMPs selected to meet the water quality treatment standard must also be shown to reduce TSS in stormwater runoff by at least 80% or to a concentration of no greater than 80 mg/L.
8. Groundwater. The highest known groundwater elevation and extent of mounding from infiltration BMPs shall be determined to ensure no adverse impacts internal and external to the development.
9. Soils. Test pits or soil borings are required for most structural BMPs to determine soil classification, depth to groundwater and the presence of other site constraints. Field permeability testing is not generally required, but must be conducted to use the alternative approach for channel protection when soils are questionable.
10. Restrictive Covenants. Plats and site condominium developments must incorporate specific requirements for lot grading, minimum floor and opening elevations, footing drains, private easements for rear and side yard drainage, and individual soil erosion and sedimentation control permits.
11. Easements. Easements are required for drainage systems accepted by the Drain Commissioner as a county drain, or for private systems with multiple land owners.
12. Operation and Maintenance. Stormwater BMPs must be designed to allow for operation and maintenance, demonstrated in the review submittals. A maintenance agreement between the Developer and the local municipality may be required by the municipality for private stormwater management systems located within their jurisdiction. A maintenance agreement between the Developer and the Drain Commissioner is required for stormwater systems established as county drains when a private entity or organization wishes to conduct the maintenance.



**Table 1 – Minimum Required Stormwater Standards**

Standard/Where Required	Criteria
<b>Water Quality “first flush”</b> All sites.	Treat the runoff generated from 1 inch of rain over the project site (i.e. the 90% annual nonexceedance storm) through BMPs designed to reduce post-development TSS loadings by 80%, or achieve a discharge concentration not to exceed 80 mg/L.
<b>Channel Protection</b> Surface water discharges; not required for direct discharge to Lake Michigan.	The post-development runoff rate and volume shall not exceed the pre-development rate and volume for all storms up to and including the 2-year, 24-hour storm. Retention of the volume increase is required.  Where site conditions preclude infiltration (onsite and offsite), an alternative approach may be allowed consistent with the flowchart in Part 1:  Extended Detention of the 2-year, 24-hour storm for a period of 24 hours resulting in a drawdown time no greater than 72 hours. The resulting peak discharge shall be no greater than the existing 1-year peak discharge.
<b>Flood Control</b> All sites; unless exception is allowed.	<u>Collection and Conveyance:</u> Design storm sewers and swales for the 10-year storm, and open channels for the 25-year storm.  <u>Detention and Retention:</u> Store runoff from the 100-year storm with a maximum release rate of 0.13 cfs per acre.  <u>Overflow Routes for Extreme Flood:</u> Identify overflow routes and the extent of high water levels for the 100-year flood to ensure no adverse impacts offsite or internal to the site. Where overland flow routes do not exist: <ol style="list-style-type: none"> <li>1. Protect buildings with redundant storm sewer system sized for the 100-year storm; and</li> <li>2. Increase size of detention and retention basins to store two (2) times the flood control volume.</li> </ol>
<b>Pretreatment</b> Refer to <a href="#">Table 3</a> .	Forebay volume equal to 15% of water quality volume (required for detention/retention basins); Vegetated Filter Strip; Vegetated Swale; or Water Quality Device.
<b>Hotspot</b> Industrial and commercial land uses in <a href="#">Table 2</a> ; Part 201 and Part 213 sites (Brownfields).	Isolate transfer and storage areas to minimize need for treatment.  Pretreatment BMP with impermeable barrier above groundwater and provisions for the capture of oil, grease, and sediments.  Minimum spill containment volume: 400 gallons.
<b>Coldwater Streams</b>	Incorporate strategies to promote groundwater recharge and/or reduce temperature of surface discharge water.

## II. STANDARDS

### A. Water Quality

#### Where Required

Treatment of the water quality volume is required for all sites to capture and treat the “first flush” of stormwater runoff that typically carries with it the highest concentration of pollutants.<sup>2</sup>

#### Standard

Capture and treatment of the runoff from the 90% annual nonexceedance storm is required for the project site. This storm is approximately equivalent to 1 inch of rain (1.00 inch for Michigan Climatic Zone 8 per DEQ memo “90 Percent Annual Nonexceedance Storms” dated March 24, 2006).

Treatment of the runoff volume from the 90% annual nonexceedance storm with properly designed BMPs to reduce TSS loading by 80%, or achieve TSS discharge concentrations not to exceed 80 mg/L, is required.

*Note:* TSS is a surrogate for other pollutants normally found in stormwater runoff. Control of TSS to meet this requirement is expected to achieve control of other pollutants to an acceptable level that protects water quality.

Natural areas of the site left undisturbed and BMPs that provide water quality treatment need not be included in the calculations. This effectively results in the directly connected impervious areas and disturbed pervious areas of the site being used to calculate the water quality volume.

#### Treatment BMPs

Selected BMPs must meet the TSS target either alone or in combination. Pollutant (TSS) removal efficiencies for BMPs are provided in [Table 2](#). Water quality volume can be provided through one of the following methods:

1. Settling (Permanent Pool or Detention)
2. Filtration
3. Infiltration
4. Absorption
5. Chemical/Mechanical Treatment

Permanent Pool. The volume of a permanent pool incorporated into a stormwater BMP and sized at 2.5 times the water quality volume.<sup>3</sup> This is the volume below the ordinary static water level (also known as dead storage).

Detention. The storage volume provided by detention of stormwater. Extended detention is defined as holding the stormwater runoff volume and releasing it gradually over a period of 24 hours with a drawdown time no greater than 72 hours.

Filtration. The volume of stormwater runoff routed through a BMP that provides filtration (i.e. an underdrained BMP). In the case of a vegetated filter strip or vegetated swale, the filtering area must meet minimum standards for slope, length, drainage area and vegetative cover.

Infiltration. The volume of stormwater runoff infiltrated into the ground through a stormwater BMP.

Absorption and Chemical/Mechanical Treatment. The volume of stormwater runoff routed through a proprietary water quality device, or natural or engineered system.

---

<sup>2</sup> Stenstrom, Michael K. and Kayhanian, Masoud (2005). *First Flush Phenomenon Characterization*. California Department of Transportation, Sacramento, California.

<sup>3</sup> Barrett, Michael (2005). *BMP Performance Comparisons: Examples from the International Stormwater BMP Database*, Center for Research in Water Resources, PRC#119, University of Texas, 2005 Water Environment Federation.

## B. Channel Protection

### Where Required

Channel protection is required for surface water discharges. Channel protection is not required for direct discharges to Lake Michigan, including directly connected storm sewer.

### Standard

The post-development runoff rate and volume shall not exceed the pre-development rate and volume for all storms up to and including the 2-year, 24-hour storm. Retention of the volume increase is required.

Pre-development is defined as the last land use prior to the planned new development or redevelopment.

Pre-settlement conditions may be necessary for channel protection in certain areas. Pre-settlement is defined as open space, woods or meadow. Watershed policies will dictate when and where pre-settlement conditions apply.

Retention can be provided through infiltration, or interception and evapotranspiration or reuse.

*Note:* Volume control for channel protection is required to mitigate increases in runoff rates and volumes for the more frequent (bankfull) rainfall events that have the greatest influence on shaping stream channels. An increase in runoff volume can expose channels to critical erosive velocities for a longer duration, causing accelerated channel adjustments to occur.

### Alternative Approach

Where site constraints limit infiltration (onsite and offsite), and field permeability testing has confirmed the limits of the infiltration rate, an alternative approach may be allowed after all other onsite BMPs are maximized consistent with the flow chart in Part 1. In urbanized areas, a certification form signed by the Design Engineer must be submitted for approval before the alternative approach can be used. An acceptable certification form is included in **Appendix 1**. Site constraints that limit the use of infiltration may include:

1. Poorly draining soils (<0.24 inches per hour; typically hydrologic soil groups C and D).
2. Bedrock.
3. High groundwater, or the potential of mounded groundwater to impair other uses.
4. Wellhead protection areas.
5. Stormwater hot spots.
6. Part 201 and Part 213 sites, and areas of soil or groundwater contamination.

The alternative approach shall consist of extended detention of the 2-year, 24-hour storm for a period of 24 hours resulting in a drawdown time no greater than 72 hours. The resulting peak discharge shall be no greater than the existing 1-year peak discharge.

*Note:* A developed peak discharge no greater than the existing 1-year peak discharge is required by the DEQ. The intent is to release stormwater runoff in such a gradual manner that critical erosive velocities during the bankfull event will seldom be exceeded in downstream channels.

If the allowable opening area for extended detention becomes too small for practical design (less than the area of a ¾-inch diameter hole), a 4-inch underdrain below a biofiltration BMP (e.g. bioretention/rain garden, planter box, water quality swale) may be used.

*Note:* Studies have shown that underdrained biofiltration BMPs provide a significant percentage of volume reduction (23% to 73% for 25<sup>th</sup> and 75<sup>th</sup> percentiles),<sup>4</sup> and a large percentage of rate reduction (80% or more).<sup>5</sup>

---

<sup>4</sup> Geosyntec Consultants and Wright Water Engineers, Inc. (May 2012). *International Stormwater Best Management Practices (BMP) Database, Addendum 1 to Volume Reduction Technical Summary (January 2011), Expanded Analysis of Volume Reduction in Bioretention BMPs.*

<sup>5</sup> University of New Hampshire Stormwater Center (2007). *2007 Annual Report.*

## C. Flood Control

### Where Required

Flood control is required for all sites.

### Standard

Detention or retention of the 100-year storm with a maximum release rate of 0.13 cfs per acre is required.

*Note:* The 100-year storm is selected to further decrease flood risk when reviewed against the economics from federal studies comparing the cost of flood damage to storm return interval.<sup>6</sup> The release rate of 0.13 cfs per acre is selected to be generally protective of floodplains in downstream watercourses and is based on result found in previous hydrologic studies on West Michigan streams.<sup>7</sup> When volume control is not provided, an extremely low release rate is required to prevent an increase in peak flow rates in downstream watercourses or storm sewers. The increased volume and prolonged duration of runoff from multiple detention basins can have a cumulative effect to increase peak flow rate and duration in downstream reaches.

An alternate maximum release rate may be allowed under certain conditions, including, but not limited to:

1. **Watershed Policy.** Sites with specific discharge requirements per a Watershed Policy Statement.
2. **Municipal Storm Sewer.** Redevelopment sites discharging to a municipal storm sewer where the municipality has determined the sewer has adequate capacity for the existing peak runoff rate from the site. Detention need only be provided for any increase in impervious area.
3. **Direct Discharge - No Volume Control.** Direct discharges to waterbodies or watercourses where the Developer demonstrates that the receiving waters possess capacity to convey a post-development discharge no greater than the pre-settlement 10-year discharge rate safely and with no negative downstream impacts due to increased flow rates, water levels or velocities. In addition, the peak flow of the receiving waters cannot be increased by the proposed development (i.e. there is a sufficient difference in the timing of the two hydrographs).
4. **Volume Control.** When the volume of runoff discharged from the developed site is equal to or less than the volume of runoff from the existing site for the 100-year design storm, the maximum allowable release rate may be increased to the pre-settlement 100-year peak discharge rate. If detention is already in use on a redevelopment site, the existing controlled release rate is the pre-development release rate.

*Note:* This approach is effective in maintaining peak flow rates and floodplain levels in downstream watercourses, since it better mimics the predevelopment hydrology of a site and eliminates the large volume increases associated with increased flooding.

5. **Floodplain.** When the site is located adjacent to or within a floodplain, excavation of new floodplain in lieu of standard stormwater detention may be required. The excavated volume shall be equal to the standard detention basin storage volume. Only the volume above the 2-year and below the 100-year floodplain elevation can be counted to meet the volume requirement.

---

<sup>6</sup> Johnson, William K. (January 1985). *Significance of Location in Computing Flood Damage*. ASCE Journal of Water Resource Planning and Management.

<sup>7</sup> Camp, Dresser and McKee, Inc. (1991). *Buck and Plaster Creek Stormwater Management Masterplan*, prepared for the Kent County Drain Commissioner.

**Overflow Routes for Extreme Flood**

Overflow routes and the extent of high water levels for the 100-year flood shall be identified for the site and for downstream areas between the site and the nearest acceptable floodway or outlet. Provisions shall be made to ensure no adverse impacts offsite or internal to the site. Where acceptable overflow routes do not exist:

1. Buildings shall be protected from flooding by two separate enclosed drainage systems, a primary and a redundant system, each independently protecting the building from flooding during the 100-year storm. Runoff shall be directed to the inlets of the primary system for up to a 10-year storm, to minimize the accumulation of debris over the redundant inlets; and
2. Detention and retention basins shall be increased in size to store two (2) times the flood control volume.

*Note:* The intent of the extreme flood criteria is to prevent flood damage from large but infrequent storm events by identifying and/or designing overland flow paths that are clear of structures and have grades below the lowest openings of structures. Overflow routes may include floodplains along open channels, overbank areas along vegetated swales, curb jumps in drives and parking lots, and other flow paths flood waters will take to reach an outlet, whether overland or underground.

## D. Pretreatment

### Where Required

Pretreatment is required prior to discharging stormwater runoff to the following structural BMPs to preserve the longevity and function of the BMP:

1. Detention basins
2. Retention basins
3. Infiltration practices
4. Bioretention/rain gardens
5. Constructed filters
6. Capture reuse

### Treatment BMPs

Pretreatment provides for the removal of fine sediment, trash, and debris. Methods of pretreatment include:

1. Forebays (including spill containment cells and level spreaders)
2. Vegetated filter strips (including buffers and green roofs)
3. Vegetated swales (including natural flow paths)
4. Water quality devices

### Standard

#### Sediment Forebay

A minimum pretreatment volume equivalent to 15% of the water quality volume is required for sediment forebays using gravity.

*Note:* This is a conservative approximation of results given by the Hazen Equation for sediment basin sizing using a 50% settling efficiency for a 50-micron particle (silt) at a maximum 4-foot settling depth with a 1-year peak inflow at a rainfall intensity of 1 inch per hour, consistent with recommendations in the *Low Impact Development Manual for Michigan* (SEMCOG, 2008).

Changes in forebay size may be allowed if sufficient design information is provided.

#### Vegetated Filter Strip

Provide a 10-foot minimum sheet-flow length at a maximum slope of 2% with an impervious approach length no greater than 3.5 times the filter strip length, up to a maximum approach length of 75 feet.

Provide a 15-foot minimum sheet flow length for slopes between 2% and 6% with an impervious approach length no greater than 3 times the filter strip length, up to a maximum approach length of 75 feet.

#### Vegetated Swale

Provide a 20-foot minimum length at a maximum slope of 4% with a 1-foot high check dam at the downstream end, and a maximum upstream drainage area of 0.13 acre per 2-foot of bottom width.

*Note:* Minimum lengths for vegetated filter strips and vegetated swales are selected to provide a workable length for small sites and right-of-way constraints, while providing an area for sediment to drop out of suspension. Vegetated filter strip sizing for pretreatment from *Design of Stormwater Filtering Systems* (Center for Watershed Protection, 1996). Vegetated swale upstream area ratio assumes a 1-year peak inflow (rainfall intensity of 2.24 inches per hour for a time-of-concentration of 15 minutes) from an impervious area, with a settling efficiency of 50% for a 50-micron particle (silt).

#### Water Quality Device

Configured to trap floatables and sediment. Follow manufacturer's guidelines.

## E. Hot Spots

### Where Required

Sites considered to be stormwater hot spots are identified in [Table 2](#). These include activities with a high potential to cause contamination, and sites that have existing contamination. More specifically:

1. Industrial and commercial land use activities involving the production, transfer, storage and/or use of hazardous materials in quantities that pose a high risk to surface and groundwater quality (exceeding 55 gallons aggregate for liquids and 440 pounds aggregate for dry weights), as defined in Part 5 Rules: Spillage of Oil and Polluting Materials, Water Resources Protection (Part 31, Act 451, PA 1994).
2. “Brownfield” sites with soil or groundwater contamination under Part 201 Environmental Remediation and Part 213 Leaking Underground Storage Tanks (Act 451, PA 1994).

### Standard

Pretreatment volume with a minimum of 400 gallons required for spill containment from hot spot land use activities.

*Note:* The minimum spill containment volume provides a reasonable capture size (e.g. a standard liquid propane truck has a hauling capacity of 1,000 gallons) that can be accommodated with a 6-foot diameter water quality device.

Pretreatment BMPs must have an impermeable barrier between the treated material and the groundwater and have provisions for the capture of oil, grease, and sediments.

### Treatment BMPs

Specific stormwater management strategies for hotspots include the following:

1. Isolate transfer and storage areas from permeable surfaces and reduce exposure to stormwater.
2. Identify opportunities for use of infiltration BMPs in other areas of the site.
3. Where storage and transfer areas exposed to stormwater cannot be avoided:
  - a. Infiltration of runoff from pavement surfaces is discouraged in favor of a surface water discharge.
  - b. Pervious pavements that infiltrate into the groundwater are not permitted because they do not allow for any pretreatment or spill containment.
  - c. Perforated pipes for infiltration are not permitted due to the difficulty in isolating an accidental spill.
  - d. A standard catchbasin and outlet pipe with a downturned end is not permitted because the area of the permanent pool is insufficient to prevent the captured low-density fluids from becoming entrained in the water when surface inflow enters the structure.

### Evaluation Procedure

Brownfield sites must be evaluated before an infiltration approach can be approved so as not to exacerbate existing conditions. The following steps must be followed for sites with known contamination:

1. Include a qualified environmental consultant on the design team.
2. Show areas of known contamination on the site map.
3. Specify on the drawings how contractor is to address any contamination which may be found during construction.
4. The site evaluation process must follow the [document](#) entitled *Implementing Stormwater Infiltration Practices at Vacant Parcels and Brownfield Sites* (EPA, 2013).
5. Submit supporting documentation of the site evaluation process with the stormwater review package.
6. Contact DEQ Remediation and Redevelopment Division (RRD) staff for consultation as necessary.

**Table 2 – Stormwater Hot Spots**

2017 North American Industry Classification System (NAICS)	
31 – 33	Manufacturing.
44 – 45	Retail Trade (441 Motor Vehicle and Parts Dealers, 444 Building Material and Garden Equipment and Supplies Dealers, 447 Gasoline Stations, 454 Non-store Retailers (e.g. fuel dealers)).
48 – 49	Transportation and Warehousing.
71	Arts, Entertainment, and Recreation (79393 Marinas).
81	Other Services (8111 Automotive Repair and Maintenance, 8113 Commercial and Industrial Machinery and Equipment Repair and Maintenance, 8123 Dry Cleaning and Laundry Services, 8129 Other Personal Services (e.g. photofinishing laboratory)).
42, 56	Salvage Yards (423930 Recyclable Material Merchant Wholesalers) and Recycling Facilities (562 Waste Management and Remediation Services).
	Brownfield Sites classified under Part 201 Environmental Remediation and Part 213 Leaking Underground Storage Tanks (Act 451, PA 1994) of the Michigan compiled laws.
	Areas with the potential for contaminating public water supply intakes.
	Other land uses and activities where petroleum products, chemicals or other polluting materials have a high probability of polluting surface or groundwater due to quantity of use, storage or waste products generated, as determined by the Drain Commissioner.
Many of these sites will also be regulated under the EPA NPDES Industrial Stormwater Program. A detailed list of NAICS industries can be found at: <a href="https://www.census.gov/cgi-bin/sssd/naics/naicsrch?chart=2017">https://www.census.gov/cgi-bin/sssd/naics/naicsrch?chart=2017</a>	

## F. Coldwater Streams

### Where Required

Coldwater streams require an adequate and stable base flow to maintain their designation and support a cold-water fishery. Designated trout stream maps are available on the DNR [website](#).

### Treatment BMPs

Development practices that increase surface water temperature or eliminate groundwater recharge should be avoided. The following strategies apply to developments located within a watershed of a designated trout stream that also propose a surface water discharge to the coldwater stream. Strategies must be identified on the site plan and/or submittal package.

1. Protect riparian buffers.
2. Stormwater disconnection.
3. Incorporate heat-reducing BMPs such as green roofs and re-forestation.
4. Implement structural BMPs that control volume through infiltration.
5. If detention ponds are used, detention times must be limited to a maximum of 12 hours.
6. Wet ponds should draw water from near the pond bottom to maintain a cooler discharge water temperature.

## G. Watershed Policy Statements

Watershed Policy Statements refer to policies of authorities having jurisdiction, or policy recommendations from engineering studies or management plans. Watershed policies may be based on the results of hydrogeologic, hydrologic and hydraulic modeling or monitoring. The policy statements identify watershed-specific stormwater management standards and the areas where they must be applied to meet resource protection goals. Watershed policies may address a variety of special stormwater management considerations (e.g. well-head protection areas, flood control zones, buffer overlay zones, TMDL allocations, regional stormwater management districts).

Watershed Policy Statements are included in **Appendix 4**. If the site is located within one of the identified watersheds or jurisdictions, the drainage plan for the site must also comply with the policy statement.



### III. DESIGN PROCESS

The stormwater site design process is summarized in the steps below. This process is intended to minimize negative impacts from development sites that could be avoided through proper planning.

#### A. Identify Sensitive Areas

Identify existing environmentally sensitive areas on the site plan that may require special consideration or pose a challenge for stormwater management. For the purpose of these rules, sensitive areas include:

1. Waterbodies (lakes and ponds)
2. Rivers and streams
3. Floodplains (and flood prone areas)
4. Riparian areas
5. Wetlands
6. Woodlands
7. Sand dunes
8. Natural drainageways
9. Soils and topography (erodible, steep, karst)
10. Susceptible groundwater supplies
11. Susceptible surface drinking water intakes
12. Threatened and endangered species habitat

Sensitive areas are determined on a site-specific basis through survey, delineation, aerial photographs, or maps. Sensitive areas must be shown on the site map or drawings. The total acreage of protected areas must also be indicated and demonstrate a good faith effort to maximize protection of sensitive areas.

#### B. Select Source Controls

Source controls reduce the volume of runoff generated onsite, encourage infiltration and evapotranspiration, and prevent pollutants from entering the drainage system. Non-structural BMPs are used for this purpose. Maximize the use of non-structural BMPs as the most effective option for controlling stormwater to meet sensitive area protection requirements and reduce the size of site runoff controls.

#### C. Size Runoff Controls

After source controls have been maximized, site runoff controls are typically needed to manage the additional post-development stormwater runoff. Determine the standards applicable to the site to properly size runoff controls. Minimum required stormwater standards are summarized in [Table 1](#). Identify additional standards required in Watershed Policy Statements.

#### D. Confirm an Adequate Outlet

Once all onsite source and runoff controls have been implemented, excess runoff can be discharged offsite. The design criteria specified in this manual is generally protective of the receiving waterbody. However, an adequate outlet must always be identified downstream of the development to receive the design rate, volume, and concentration of the post-development site runoff. Discharge from the site, including discharge from emergency overflow spillways and pipes, must not cause adverse impact to downstream property or infrastructure (refer to Part 2 section “Stormwater Discharge”).

#### E. Select Best Management Practices (BMPs)

Select appropriate BMPs to meet minimum required pollutant reduction, volume, and peak rate requirements. A list of common BMPs and their treatment ability is given in [Table 3](#). The BMPs selected must be designed in accordance with the calculation methods and design criteria provided in this manual. BMPs proposed for use, but not included in this manual, will be evaluated on an individual basis.

Table 3 – Stormwater BMP Matrix

Stormwater BMP	Treatment			
	Requires Pretreatment	TSS Removal Efficiency	Provides Pretreatment	Provides Spill Containment
<b>Non-Structural BMPs</b>				
Minimal Disturbance Area				
Protect Natural Flow Pathways			X	
Protect Sensitive Areas				
Native Revegetation			X	
Stormwater Disconnect				
<b>Structural BMPs – Conveyance and Storage</b>				
Storm Sewer		(22)		X
Culvert or Bridge				
Open Channel				
Detention Basin (dry)		(49)		
Detention Basin (wet)		(80)		
Detention Basin (extended/wetland)		(72)		
Retention Basins	X	(89)		
Sediment Forebay		(50)	X	
Spill Containment Cell		(50)	X	X
<b>Structural BMPs – LID and Small Site</b>				
Infiltration Practices	X	(89)		
Bioretention/Rain Garden*	X	(86)		
Bioswale*		(86)	X	
Constructed Filter	X	(86)	X	
Planter Box*		(59)		
Pervious Pavement*		(84)		
Pervious Pavement* (roof discharge to stone)		(50)		
Capture Reuse	X	(*)		X
Vegetated Roof		(*)	X	
Water Quality Device		(*)	X	X
Water Quality Swale		(86)	X	X
Vegetated Swale		(81/50)	X	
Vegetated Filter Strip		(81/50)	X	
Level Spreader			X	
Blank	No. BMP does not provide treatment.			
X	Yes.			
( )	BMP may be used to meet water quality treatment criteria. Median TSS Removal Efficiency in percent. Source: Fraley-McNeal, L. (September 2007). <i>National Pollutant Removal Performance Database, Version 3</i> , Center for Watershed Protection. Bioretention/Rain Garden, Bioswale and Water Quality Swale same as Constructed Filter. Pervious Pavement average TSS Removal. Source: Rowe, Amy A., Borst, Michael, and O'Connor, Thomas P. (2007). <i>Pervious Pavement System Evaluation</i> , EPA, Office of Research and Development. Storm Sewer average TSS removal for standard catch basin. Source: Pitt, R. and Field, R. (1998). <i>An Evaluation of Storm Drainage Inlet Devices for Stormwater Quality Treatment</i> , WEFTEC'98 Water Environment Federation 71st Annual Conference & Exposition, Proceedings Volume 6, Facility Operations I&II. Sediment Forebay, Spill Containment Cell, and Vegetated Swale/Vegetated Filter Strip sized for pretreatment: 50% settling efficiency used.			
( / )	BMP sized for water quality treatment / BMP sized for pretreatment only.			
(*)	NJDEP certified; or submit independent third-party testing results of pollutant removal efficiency for review. <a href="http://www.nj.gov/dep/stormwater/treatment.html">http://www.nj.gov/dep/stormwater/treatment.html</a>			
*	TSS removal efficiency assumes underdrained BMP, use value for Infiltration Practices if BMP has no underdrain.			
Notes:	Design criteria in this manual is provided to meet or exceed the median TSS removal efficiency.			

## I. SOILS INVESTIGATION

### A. Qualifications

Soils investigation by a qualified geotechnical consultant is required for retention and detention basins, infiltration practices, bioretention/rain gardens, constructed filters, planter boxes, and pervious pavement to determine the site soil infiltration characteristics and groundwater level. The geotechnical consultant shall be a professional engineer, soil scientist, or professional geologist.

### B. Background Evaluation

An initial feasibility investigation shall be conducted to screen proposed BMP sites. The investigation involves review of the following resources:

1. County Soil Survey prepared by the NRCS and USDA Hydrologic Soil Group (HSG) classifications.
2. Existing soil borings, wells, or geotechnical report on the site.
3. Onsite septic percolation testing.
4. Cyclical groundwater levels <http://waterdata.usgs.gov/mi/nwis/gw>

### C. Test Pit/Soil Boring Requirements

A test pit (excavated trench) or soil boring shall be used for geotechnical investigation. Test pits may typically be selected for shallower investigations in locations where groundwater is sufficiently low.

The number of test pits or soil borings will vary depending on site conditions and the proposed development. The minimum number of test pits or soil borings shall be determined from **Table 4**.

Additional tests may be requested based on local conditions and initial findings (e.g. large variability in soil type, high groundwater table).

**Table 4 – Minimum Number of Soil Tests Required**

Type of BMP	Test Pit/Soil Boring	Depth of Test Pit/ Soil Boring	Field Permeability Test	
			Design	Post-construction
Retention basin	1 per 5,000 square feet of bottom area; 1 minimum	10 feet below proposed bottom	1 per change in soil class; 1 minimum	1 minimum
Infiltration bed Pervious pavement				No
Infiltration trench	1 per 500 to 1,000 linear feet of BMP; 1 minimum	5 feet below proposed bottom	1 per change in soil class; 1 minimum	No
Bioswale				1 minimum
Dry well Leaching basin	1 minimum	5 feet below proposed bottom	1 per change in soil class; 1 minimum	No
Bioretention/Rain garden Planter box				1 minimum
Detention basin	1 per 10,000 square feet of bottom area; 1 minimum	5 feet below proposed bottom	No	No

Excavate a test pit or soil boring in the location of the proposed BMP. The following conditions shall be noted and described, referenced from a top-of-ground elevation:

1. Depth to groundwater recorded during initial digging or drilling, and again upon completion of the excavation.
2. Depth to bedrock or hardpan.
3. Depth and thickness of each soil horizon including the presence of mottling.
4. Unified Soil Classification System for all soil horizons. USDA soil texture classification when required.

Test pit reports and soil boring logs shall include the date(s) data was collected and the location referenced to a site plan.

## D. Highest Known Groundwater Elevation

The highest known groundwater elevation shall be determined by adjusting the measured groundwater elevation using indicators such as soil mottling and regional water level data. It should also take into consideration local conditions that may be temporarily altering water levels at the time of measurement. Such conditions could include, but not be limited to: dewatering, irrigation well or large quantity withdrawals in the area, or areas of groundwater infiltration (such as a nearby retention basin).

## E. Field Permeability Testing

Field permeability testing is generally not required, but may be performed to determine a design infiltration rate. The Drain Commissioner reserves the right to request that field permeability testing be performed. Field permeability testing must be conducted for questionable soils before the alternative approach for channel protection will be considered.

Acceptable field tests include:

1. Infiltration Rate of Soils in Field Using Double-Ring Infiltrimeters (ASTM D3385).
2. Modified double-ring infiltration testing, using smaller diameter metal or plastic casings, where bore hole is required to reach design depth. The “Methodology for double-ring infiltrimeter field test” outlined on page 440 in [Appendix E](#) of the Low Impact Development Manual for Michigan (SEMCOG, 2008) shall be followed for each test.

Laboratory tests are not allowed.

The minimum number of field permeability tests shall be determined from [Table 4](#). The Drain Commissioner reserves the right to request additional field permeability tests be performed.

Tests shall be conducted in the location of the proposed BMP at the proposed bottom elevation. An alternate testing depth may be allowed if material is identical and groundwater is not an issue.

Tests shall not be conducted in the rain or within 24 hours of significant rainfall events (>0.5 inch) or when the ground is frozen.

Test reports shall include the date(s) data was collected and the location referenced to a site plan.

## F. Design Infiltration Rates

The procedure used to determine a design infiltration rate is summarized in **Table 5**. The resulting design infiltration rate shall be the limiting value of the underlying soil or filter media/top dressing.

**Table 5 – Determination of a Design Infiltration Rate**

Description	Source	Maximum Design Infiltration Rate
1. Underlying soil		
Field permeability testing conducted	Test value divided by 2	10 in/hr
No testing; Retention basins used for flood control	Table 6	3.6 in/hr
2. Filter media/top dressing	Table 14	As calculated

The infiltration rate determined from field permeability testing shall be divided by 2 to calculate the design infiltration rate, up to a maximum design infiltration rate of 10 inches per hour. The least permeable soil horizon within 4 feet below the proposed BMP bottom elevation shall be used to select the design infiltration rate.

Where field permeability testing is not performed, and for all retention basins used for flood control, the design infiltration rates provided in **Table 6** shall be used to calculate the storage volume and minimum infiltration area of the BMP necessary to drain in the allotted drawdown time.

*Note:* A conservative value for the infiltration rate is used for retention basins due to the high probability for diminished performance due to clogging and the risk of failure.

When a filter material is used, or several materials are blended together in a homogenous mixture, the hydraulic conductivities provided in **Table 14** shall be used to calculate the design infiltration rate through the filter media/top dressing placed in retentive BMPs.

**Table 6 – Design Infiltration Rates by USDA Soil Texture Class**

Soil Texture Class	Effective Water Capacity <sup>1</sup> (inches per inch)	Design Infiltration Rate <sup>2</sup> (inches per hour)	HSG
Gravel	0.40	3.60	A
Sand	0.35	3.60	A
Loamy Sand	0.31	1.63	A
Sandy Loam	0.25	0.50	A
(Medium) Loam	0.19	0.24	B
Silty Loam / (Silt)	0.17	0.13	B
Sandy Clay Loam	0.14	0.11	C
Clay Loam	0.14	0.03	D
Silty Clay Loam	0.11	0.04	D
Sandy Clay	0.09	0.04	D
Silty Clay	0.09	0.07	D
Clay	0.08	0.07	D

<sup>1</sup>Source: Maryland Department of Environment (2000). *Maryland Stormwater Design Manual*, Appendix D.13, Table D.13.1 (Rawls, Brakensiek and Saxton, 1982).

<sup>2</sup>Source: Wisconsin Department of Natural Resources (2004). *Site Evaluation for Stormwater Infiltration (1002)*, Table 2 (Rawls, 1998). *Note:* Values are reduced by approximately a factor of 2 from those given in Table D.13.1.

**Table 6** provides design values of the infiltration rate and effective water capacity (void ratio) for soils based on their textural classification. Soil textural classes correspond to the USDA Soil Textural Triangle shown in **Figure 1**.

*Note:* Infiltration is the process by which water on the ground surface enters the soil. Infiltration rate is a measure of the rate at which soil is able to absorb rainfall or irrigation in inches per hour. The rate decreases as the soil becomes saturated. The design infiltration rate assumes saturated conditions and closely approximates the hydraulic conductivity (typically given in feet per day) of the near-surface soil.

*Note:* The effective water capacity of a soil is the fraction of the void spaces available for water storage measured in inches per inch.

### G. Minimum Allowable Infiltration Rate

Soil textures with design infiltration rates less than 0.24 inches per hour are deemed not suitable for infiltration BMPs.

Soils with design infiltration rates between 0.24 and 0.50 inches per hour may be used for LID and Small Site BMPs if suitable supplemental measures are included in the design. Supplemental measures may include subsoil amendment, underdrain placed at the top of the storage bed layer, or placement of wick drains.

Figure 1 – USDA Soil Textural Triangle

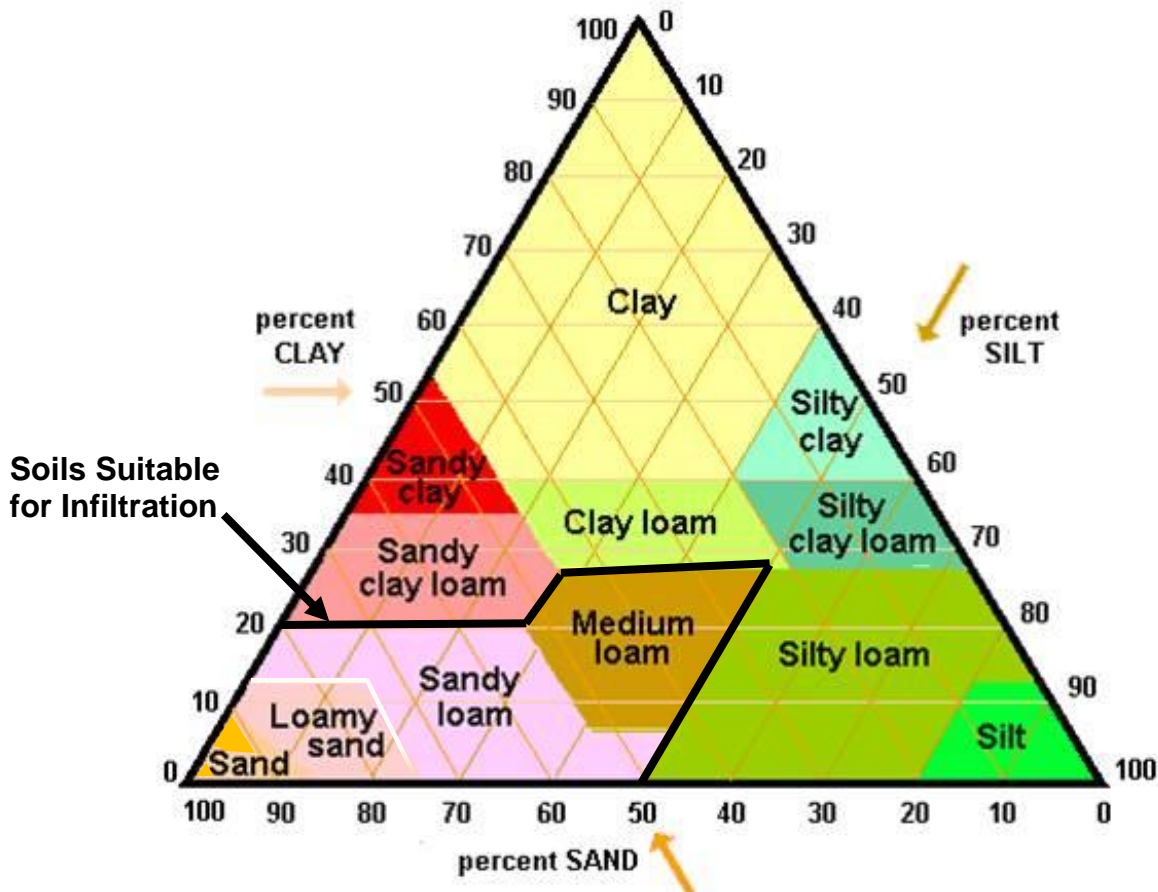

## II. CALCULATION METHODOLOGY

The Rational Method and the NRCS Runoff Curve Number Method are typically used to calculate stormwater runoff, peak discharges and runoff volumes for design of stormwater conveyance and storage systems.

The NRCS Method is presently the only acceptable method to calculate the channel protection volume.

The Small Storm Hydrology Method is used to calculate runoff volumes from the smaller rainfall amounts used for water quality treatment.

### A. Calculating Runoff

#### 1. Rational Method

The Rational Method may be used to calculate stormwater runoff volumes and peak discharges to size conveyance and storage systems for contributing drainage areas of 40 acres or less. The peak runoff rate is given by the equation:

$$Q = CIA \quad (4.1)$$

where:

- $Q$  = peak runoff rate (cubic feet per second).
- $C$  = weighted runoff coefficient of the drainage area.
- $I$  = average rainfall intensity for a storm with a duration equal to the time of-concentration of the drainage area (inches per hour). Use rainfall amounts from **Table 11** and divide by the duration in hours to obtain the average rainfall intensity ( $I$ ).
- $A$  = drainage area (acres).

Runoff coefficients shall be selected from **Table 7**. Lawns and Open reflect average slopes (2% to 7%). Subtract 0.05 for flat pervious slopes (0% to 7%). Add 0.05 for steep pervious slopes (over 7%).<sup>8</sup>

**Table 7 – Rational Method Runoff Coefficients (5- to 100-year rainfall frequencies)**

Character of Surface	Return Period (years)			
	5	10	25	100
Asphalt and Concrete Pavement/Roofs	0.93	0.95	0.97	0.98
Brick Pavement and Gravel Surface	0.82	0.85	0.88	0.91
Lawns and Open (HSG A)*	0.10	0.15	0.17	0.20
Lawns and Open (HSG B)	0.14	0.20	0.27	0.38
Lawns and Open (HSG C)	0.32	0.35	0.45	0.55
Lawns and Open (HSG D)	0.43	0.50	0.57	0.67
Water	1.00	1.00	1.00	1.00

Source: Runoff coefficients are calculated to match 24-hour runoff volumes from CN Method with antecedent moisture condition II and initial abstract ( $I_a$ ) = 0.2S using CNs for “Open Spaces, Good Condition” for Lawns and Open, and a CN of 95 for Brick Pavement and Gravel Surface.

\*The runoff coefficient for Lawns and Open (HSG A) is adjusted to match values in American Society of Civil Engineers and the Water Pollution Control Federation (1969). *Design and Construction of Sanitary and Storm Sewers*, as the calculated value is less than 0.01. Frequency adjustment factors of 1.1 and 1.25 have been applied for the 25- and 100-year frequencies respectively, with a maximum value of 1.00. Adjustment factors from Mays (2001). *Stormwater Collection Systems Design Handbook*.

<sup>8</sup> C.T. Hann, B.J. Barfield, J.C. Hayes (1994). *Design Hydrology & Sedimentology for Small Catchments*.

Time-of-concentration for the Rational Method is the sum of overland flow and channel flow. A minimum of 15 minutes shall be used.

Overland flow time may be calculated using the following formula:

$$t_o = \left( \frac{2Ln}{3\sqrt{s}} \right)^{0.4673} \tag{4.2}$$

where:

- $t_o$  = time of overland flow (minutes)
- $L$  = length (feet); the distance from the extremity of the subcatchment area in a direction parallel to the slope until a defined channel is reached. Overland flow will become channel flow within 1,200 feet in almost all cases\*
- $n$  = surface retardants coefficient (from **Table 8**)
- $s$  = slope (feet per foot); the difference in elevation between the extremity of the subcatchment area and the point in question divided by the horizontal distance

**Table 8 – Surface Retardants Coefficients**

Type of Surface	Coefficient (n value)
Smooth impervious surface	0.02
Smooth bare packed soil	0.10
Poor grass, cultivated row crops, or moderately rough bare surface	0.20
Pasture or average grass	0.40
Deciduous timberland	0.60
Conifer timberland, deciduous timberland with deep forest litter, or dense grass	0.80

\*Source: Formula, coefficients and empirical observations from W.S. Kerby, J.M. Asce. Servis, Van Doren & Hazard Engineers, Topeka, Kansas. "Time of Concentration for Overland Flow" ENGINEER'S NOTEBOOK.

Channel flow shall be calculated using Manning's equation:

$$V = \frac{An}{1.49R^{\frac{2}{3}}S^{\frac{1}{2}}} \tag{4.3}$$

where:

- $V$  = velocity (feet per second)
- $A$  = wetted area (square feet)
- $n$  = Manning's roughness coefficient (from **Table 12**)
- $R$  = hydraulic radius (feet)
- $S$  = slope (feet per foot)

The time-of-concentration is then:

$$Tc = t_o + \frac{L_c}{60V} \tag{4.4}$$

where:

- $Tc$  = time-of-concentration (minutes)
- $t_o$  = time of overland flow (minutes)
- $L_c$  = length of channelized flow (feet)
- $V$  = velocity of channelized flow (feet per second)
- $60$  = factor to convert seconds to minutes



## 2. Runoff Curve Number Method

The Runoff Curve Number Method developed by the NRCS may be used to calculate stormwater runoff volumes and peak discharges to size conveyance and storage systems. This method must be used when it is necessary to calculate runoff volumes for channel protection. The formulas are as follows:

$$Q_v = \frac{(P - 0.2S)^2}{(P + 0.8S)} \quad (4.5)$$

where:

$Q_v$  = surface runoff (inches). *Note:*  $Q_v=0$  if  $P \leq 0.2S$

$P$  = rainfall (inches)

$S$  = potential maximum retention after runoff begins (inches)

and where:

$$S = \frac{1000}{CN} - 10 \quad (4.6)$$

Surface runoff ( $Q_v$ ) is calculated separately for each land use and soil type combination. Total runoff volume can then be calculated by the formula:

$$V_t = (\sum_i Q_{vi} A_i) \times 3630 \quad (4.7)$$

where:

$V_t$  = total runoff volume of the design storm (cubic feet)

$Q_v$  = surface runoff for the  $i^{\text{th}}$  land use (inches)

$A$  = contributing area associated with the  $i^{\text{th}}$  land use (acres)

3630 = factor to convert acre-inches to cubic feet

Curve Number (CN) values are taken from NRCS TR-55, and provided in [Table 9](#).

The “Water” cover type shall be used for detention/retention basins with a permanent pool or surface water temporarily ponded during the rain event. The “Meadow” or “Open spaces” cover type may be used for vegetative BMPs, including those that temporarily pond surface water, to receive credit for channel protection.

### Peak Discharge

The LGROW Design Spreadsheet, the DEQ procedure outlined in “Computing Flood Discharges for Small, Ungaged Watersheds” by Richard Sorrell, or NRCS computer software such as NRCS WinTR-55 may be used to calculate peak stormwater runoff rates.

A Michigan Unit Hydrograph is used in the LGROW Design Spreadsheet, the DEQ small ungaged watershed spreadsheet, and can be input into WinTR-55. The ordinates for the Michigan Unit Hydrograph for TR-55 are: [0.0, 0.5, 1.0, 0.8, 0.6, 0.4, 0.2 and 0.0].

*Note:* Using the standard NRCS unit hydrograph will overestimate peak runoff rates by 30 to 50 percent or more.

**Table 9 – Curve Numbers (CNs) from TR-55**

Land Use Description		Curve Number <sup>1</sup>			
Cover Type	Hydrologic Condition <sup>2</sup>	Hydrologic Soil Group			
		A	B	C	D
Cultivated land	Good	64	75	82	85
Pasture or range land	Poor	68	79	86	89
	Fair	49	69	79	84
	Good	39	61	74	80
Meadow		30	58	71	78
Orchard or tree farm <sup>3</sup>	Poor	57	73	82	86
	Fair	43	65	76	82
	Good	32	58	72	79
Woods	Poor	45	66	77	83
	Fair	36	60	73	79
	Good	30 <sup>4</sup>	55	70	77
Open spaces (grass cover) <sup>5</sup>	Poor	68	79	86	89
	Fair	49	69	79	84
	Good	39	61	74	80
Paved parking lot, roof, driveway		98	98	98	98
Gravel <sup>6</sup>		88	93	94	95
Bare Soil		77	86	91	94
Water <sup>7</sup>		100	100	100	100

Source: U.S. Department of Agriculture Soil Conservation Service (1986). *Urban Hydrology for Small Watersheds, Technical Release No. 55.*

<sup>1</sup>Antecedent moisture condition II and initial abstract ( $I_a$ ) = 0.2S

<sup>2</sup>Poor Condition: pasture or open space with less than 50% ground cover or heavily grazed with no mulch; woods - forest litter, small trees, and brush are destroyed by heavy grazing or regular burning.  
Fair Condition: pasture or open space with 50% to 75% grass cover and not heavily grazed; woods are grazed but not burned, and some forest litter covers the soil.  
Good Condition: cultivated land (row crops, straight row) with conservation treatment (crop residue cover), also small grain; pasture or open space with 75% or more ground cover and lightly or only occasionally grazed; woods are protected from grazing, and litter and brush adequately cover the soil.

<sup>3</sup>CN's shown were computed for areas with 50% woods and 50% pasture (grass) cover. Other combinations of conditions may be computed from the CN's for woods and pasture.

<sup>4</sup>Actual curve number is less than 30; use CN = 30 for runoff computations.

<sup>5</sup>CN's shown are equivalent to those of pasture.

<sup>6</sup>Surface only; not including right-of-way.

<sup>7</sup>Water added.

Time-of-concentration for the Runoff Curve Number Method shall be calculated using NRCS TR-55 methodology as outlined below. A minimum of 0.1 hour (6 minutes) shall be used.

The flow path is split into three sections – sheet flow, shallow concentrated flow, and open channel flow. The travel time is computed for each flow regime. The time-of-concentration is then the sum of the travel times:

$$Tc = t_1 + t_2 + t_3 \quad (4.8)$$

(1) For sheet flow the travel time ( $t_1$ ) in hours is given as:

$$t_1 = \frac{0.007(nL)^{0.8}}{P_2^{0.5}s^{0.4}} \quad (4.9)$$

where:

- $n$  = Manning's roughness coefficient (from TR-55 Table 3-1)
- $L$  = flow length (feet)
- $P_2$  = 2-year, 24-hour precipitation depth (from **Table 11**)
- $s$  = slope (feet/foot)

(2) Shallow concentrated flow velocities are calculated for paved and unpaved surfaces. The velocities are given as:

$$v = \begin{matrix} 16.1345s^{0.5} & \text{Unpaved} \\ 20.3282s^{0.5} & \text{Paved} \end{matrix} \quad (4.10)$$

where:

- $s$  = slope (feet/foot)
- $v$  = velocity (feet per second)

The flow length (feet) is then divided by the velocity (feet per second) and a conversion factor of 3600 to obtain travel time ( $t_2$ ) in hours:

$$t_2 = \frac{L}{3600 v} \quad (4.11)$$

(3) Open channel flow uses Manning's equation to calculate the velocity based on slope, flow area, and wetted perimeter (refer to Equation 4.3). The flow length (feet) is then divided by the velocity (feet per second) to obtain travel time ( $t_3$ ) in hours (refer to Equation 4.11).

#### BMP Residence Time

BMP residence time shall be calculated as the storage volume divided by the 10-year peak inflow rate.

### 3. Small Storm Hydrology Method

The Small Storm Hydrology Method is used to calculate the water quality treatment volume. The method was developed to estimate the runoff volume from urban land uses for relatively small storm events where the Rational and NRCS Methods prove less accurate. Water quality volume is calculated by the formula:

$$V_{wq} = ARv(1)(3630) \tag{4.12}$$

where:

- $V_{wq}$  = minimum required water quality volume (cubic feet)
- $A$  = area (acres); the developed portion of the site, both impervious and pervious, not receiving treatment with a non-structural BMP
- $Rv$  = area-weighted volumetric runoff coefficient (from **Table 10**)
- $1$  = 90% non-exceedance storm rainfall amount (inches)
- $3630$  = factor to convert acre-inches to cubic feet

*Note:* The Volumetric Runoff Coefficients ( $Rv$ ) provided in **Table 10** are similar to the Rational runoff coefficient, but are exclusive to the rainfall amount (1-inch).

**Table 10 – Runoff Coefficients for Small Storm Hydrology Method**

Rainfall Amount (inches)	Volumetric Runoff Coefficient, $Rv$					
	Directly Connected Impervious Area			Disturbed Pervious Area		
	Flat Roofs/ Unpaved	Pitched Roofs	Paved	Sandy Soils (HSG A)	Silty Soils (HSG B)	Clayey Soils (HSG C&D)
1.0	0.815	0.965	0.980	0.035	0.120	0.2015

Source: Adapted from SEMCOG (2008). *Low Impact Development Manual for Michigan*, Table 9.3. (R. Pitt (2003). *The Source Loading and Management Model (WinSLAMM): Introduction and Basic Uses*).

The area-weighted volumetric runoff coefficient,  $Rv$ , is calculated as:

$$Rv = \frac{A_1Rv_1 + A_2Rv_2 + \dots + A_nRv_n}{A}$$

where:

- $Rv_n$  = runoff coefficient for sub-area n
- $A_n$  = area of sub-area n (acres)
- $A$  = Sum of the areas of all sub-areas (acres)

## B. Rainfall

The rainfall duration-frequency table provided in **Table 11** shall be used with the Rational Method to determine rainfall intensity for rainfall duration equal to the time-of-concentration. Divide the rainfall amount by the duration in hours to obtain the rainfall intensity.

The 24-hour rainfall amounts provided in **Table 11** shall be used with the Runoff Curve Number Method.

An MSE4 rainfall distribution shall be used when a unit hydrograph approach is used (e.g. WinTR-55 computer program).

**Table 11 – Rainfall Amounts (inches)**

Duration	1-Year	2-Year	5-Year	10-Year	25-Year	50-Year	100-Year
24-hr	2.27	2.57	3.16	3.72	4.62	5.40	6.26
12-hr	1.99	2.26	2.78	3.29	4.11	4.83	5.64
6-hr	1.71	1.97	2.47	2.95	3.70	4.35	5.07
3-hr	1.44	1.69	2.13	2.55	3.19	3.73	4.32
2-hr	1.30	1.52	1.92	2.29	2.84	3.31	3.82
1-hr	1.05	1.23	1.55	1.84	2.28	2.64	3.03
30-min	0.81	0.94	1.18	1.40	1.71	1.97	2.25
15-min	0.56	0.66	0.82	0.97	1.19	1.36	1.55
10-min	0.46	0.54	0.68	0.80	0.97	1.12	1.27
5-min	0.32	0.37	0.46	0.54	0.66	0.76	0.87

Source: NOAA (2013). *Atlas 14, Precipitation-Frequency Atlas of the United States, Volume 8, Version 2.0*.  
Rainfall amounts from: ALLEGAN 5NE. Station ID 20-0128.

## C. Calculating Storage Volumes and Release Rates

### 1. Water Quality

Treatment of the runoff generated from 1 inch of rain (the 90% annual nonexceedance storm) over the developed portion of the site is required. Water quality volume is calculated using the Small Storm Hydrology Method.

A 1-year frequency rainfall may be used with the time-of-concentration of the contributing drainage area to calculate the peak flow rate for sizing diversion structures and treatment BMPs.

*Note:* A 1-inch, 1-hour rainfall has approximately a 1-year frequency of occurrence. The use of a constant rainfall frequency allows for reasonable sizing of infrastructure for drainage areas with times-of-concentration less than 1 hour, since 1-inch of rain over these shorter durations results in high intensities and rainfall frequencies on the order of those used for flood control.

Calculation of the TSS removal efficiency for BMPs in a series is given in Part 4 section “TSS Accounting.”

### 2. Pretreatment

Pretreatment volume may be included in the total water quality volume, and is calculated as:

$$V_{pt} = 0.15(V_{wq}) \quad (4.13)$$

where:

$V_{pt}$  = minimum required pretreatment volume (cubic feet)

$V_{wq}$  = water quality volume (cubic feet)

### 3. Channel Protection

#### a. Retention

Channel protection consists of retaining onsite the net increase in runoff volume between pre-development and post-development conditions for a 2-year, 24-hour storm using the Runoff Curve Number Method. Channel protection volume is calculated with the following equation:

$$V_{cp} = V_{t_{post}} - V_{t_{pre}} \quad (4.14)$$

where:

$V_{cp}$  = minimum required channel protection volume (cubic feet)

$V_{t_{post}}$  = total runoff volume of the 2-year, 24-hour storm for post-development conditions

$V_{t_{pre}}$  = total runoff volume of the 2-year, 24-hour storm for pre-development conditions

When a pre-settlement condition is required: The “Open Spaces” cover type in “fair” hydrologic condition shall be used for existing impervious surfaces. The “Woods” cover type in “good” hydrologic condition shall be used for existing woods. The “Meadow” cover type shall be used for all other existing land covers.

**b. Extended Detention**

The storage volume of an extended detention basin shall be sized for that part of the 2-year volume difference not met by retention, with a maximum release rate that results in a 24-hour detention time. The peak discharge for a 24-hour detention time may be calculated assuming triangular inflow and outflow hydrographs with a lag between the peaks of 24 hours. If the inflow peak occurs 12 hours into the 24-hour inflow hydrograph, the outflow peak should occur 36 hours into a 72-hour outflow hydrograph as shown in **Figure 2**. The extended detention peak discharge can then be computed with the following equation:

$$Q_{ED} = (V_{cp} - V_{ret}) / (36 * 3600) \quad (4.15)$$

where:

- $Q_{ED}$  = peak extended detention release rate (cubic feet per second)
- $V_{cp}$  = total channel protection volume required (cubic feet)
- $V_{ret}$  = channel protection volume met by retention (cubic feet)
- $36 * 3600$  = half of the base time of outflow hydrograph (seconds)

The 2-year peak discharge after extended detention ( $Q_{ED}$ ) must be equal to or less than the existing 1-year peak discharge. (Exceptions may be made for HSG A, where extended detention has been approved due to site constraints, but existing runoff is zero.) If the 1-year peak discharge limit is not met, the total channel protection volume provided must be increased to reduce the required extended detention volume. Simply using a lower extended detention release rate will violate the 72-hour drawdown time requirement.

**Figure 2 – Extended Detention Hydrograph**

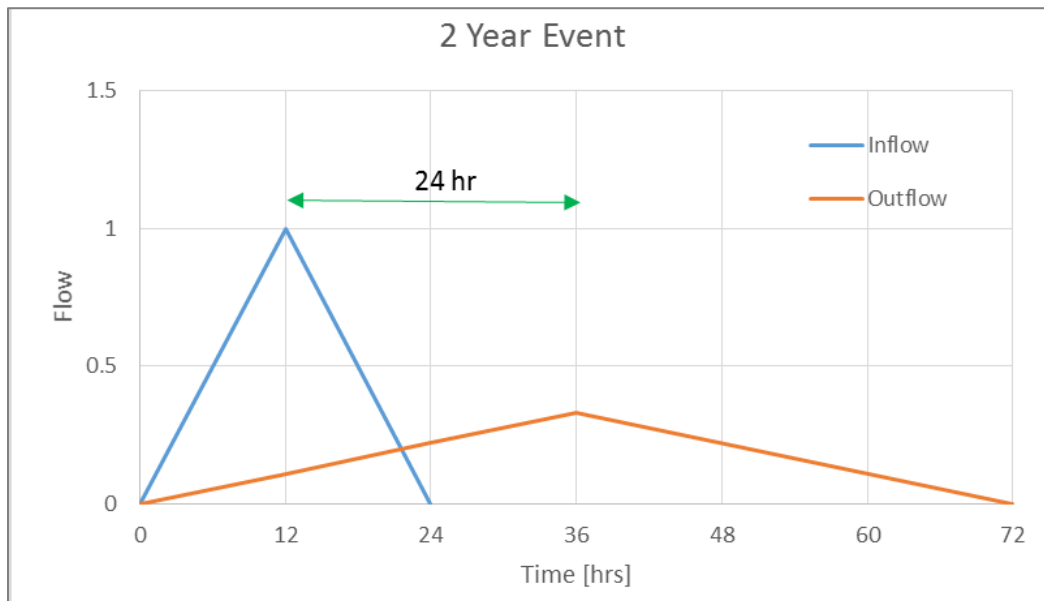

## 4. Flood Control

### a. Detention

Detention of the 100-year rainfall event with a maximum allowable release rate of 0.13 cfs per acre is required, unless an exception is allowed.

#### (1) Rational Method for Detention

If the Rational Method is used, the minimum required storage volume shall be calculated by the “Modified Chicago” Method.

The calculated storage volume shall be multiplied by 1.25 to obtain the minimum required storage volume.

*Note:* This additional adjustment is necessary since the Modified Chicago Method tends to underestimate the storage volume when compared to pond routing, particularly for short times-of-concentrations (15 to 30 minutes)<sup>9</sup>.

#### (2) Runoff Curve Number Method for Detention

If the Runoff Curve Number Method is used, the minimum required storage volume shall be determined through routing using the LGROW Design Spreadsheet, or may be calculated by the formula:

$$V_{fc} = \frac{(Qp - Q_{out})}{Qp} (Vt - V_{bmp}) \quad (4.16)$$

where:

- $V_{fc}$  = minimum required storage volume for flood control (cubic feet)
- $Qp$  = peak runoff rate (cubic feet per second)
- $Q_{out}$  = maximum allowable peak discharge (cubic feet per second)
- $Vt$  = total post-development runoff volume for the 100-year, 24-hour storm (cubic feet)
- $V_{bmp}$  = volume (storage + infiltrating) provided by upstream retentive BMPs (cubic feet)

*Note:* This formula provides a conservative approximation of the required storage volume.

---

<sup>9</sup> Stahre, Peter and Urbonas, Ben (1990). Stormwater Detention For Drainage, Water Quality and CSO Management, pp. 268 274.



**b. Retention**

Retention basins shall be sized for the 100-year, 24-hour rainfall event.

**(1) Rational Method for Retention**

If the Rational Method is used, the minimum required storage volume shall be calculated by the “Modified Chicago” Method.

The calculated storage volume shall be multiplied by 1.25 to obtain the minimum required storage volume.

The discharge or exfiltration rate into the soil from the retention basin shall be calculated as:

$$Q_{out} = Ai / (12 \times 3600) \quad (4.17)$$

where:

- $Q_{out}$  = discharge rate (cubic feet per second)
- $A$  = infiltration area (square feet)
- $i$  = design infiltration rate (inches per hour)
- $12$  = factor to convert inches to feet
- $3600$  = factor to convert hours to seconds

**(2) Runoff Curve Number Method for Retention**

If the Runoff Curve Number Method is used, the minimum required storage volume shall be calculated by the formula:

$$V_{fc} = Vt - V_{inf} \quad (4.18)$$

where:

- $V_{fc}$  = minimum required storage volume for flood control (cubic feet)
- $Vt$  = total post-development runoff volume for the 100-year, 24-hour storm (cubic feet)
- $V_{inf}$  = infiltrating volume (cubic feet), calculated the same as indicated in “Retentive BMPs Sized for Channel Protection or Water Quality”

The sum of the storage and infiltrating volumes from all retentive BMPs must equal the total runoff volume ( $Vt$ ).

**5. Retentive BMPs Sized for Channel Protection or Water Quality**

The BMP volume ( $V_{bmp}$ ) credited towards meeting the channel protection or water quality volume is the storage volume of the BMP plus the volume infiltrated by the BMP during the infiltration time.

The infiltrating volume shall be calculated with an iterative process using the following equations, or with the LGROW Design Spreadsheet, which incorporates these equations. The infiltrating volume is calculated as:

$$V_{inf} = i * A * t_{inf} / 12 \quad (4.19)$$

where:

- $V_{inf}$  = infiltrating volume (cubic feet)
- $i$  = design infiltration rate (inches per hour)
- $A$  = infiltration area (square feet)
- $t_{inf}$  = infiltration time (hours); the period when the BMP is receiving runoff and capable of infiltrating at the design rate
- 12 = factor to convert inches to feet

The infiltration time shall be calculated by the formula:

$$t_{inf} = 2.0 + t_d \left( 0.222 - 0.553 * \log_{10} \left( t_d / 72 \right) \right) \quad (4.20)$$

*Note:* Based on extensive computer modelling, the infiltration time is found to be a function of the drain time through the BMP. An empirical formula was developed to model this function for drain times between 0 and 72 hours. This equation is not valid for drain times greater than 72 hours.

The drain time through the BMP is calculated as:

$$t_d = 12 * V_s / (A * i) \quad (4.21)$$

where:

- $t_d$  = BMP drain time (hours)
- $V_s$  = storage volume of the BMP (cubic feet)
- $i$  = design infiltration rate (inches per hour)
- $A$  = infiltration area (square feet)
- 12 = factor to convert inches to feet

## D. Groundwater Mounding

A spreadsheet developed by the USGS is recommended to calculate the extent of groundwater mounding beneath infiltration BMPs. The USGS Scientific Investigations [Report 2010-5102](#) "Simulation of Groundwater Mounding Beneath Hypothetical Stormwater Infiltration Basins," may be used with the accompanying spreadsheet, which solves the Hantush (1967) equation to predict the extent of groundwater mounding based on user-specified site conditions. Other finite-difference groundwater flow models such as USGS MODFLOW are also acceptable.

## E. Computing Tools

Hydrologic and hydraulic calculations can be performed using a variety of customized spreadsheets and computer software. The LGROW Design Spreadsheet shall be used to determine minimum required storage and treatment volumes. Results of computer models that use detailed routing methods to optimize storage volumes may be considered for more complex situations. Accompanying design calculations may include hand calculations or spreadsheets using the formulas specified in this manual, and computer models with submittal of clear and complete input and output.

## F. LGROW Design Spreadsheet

The LGROW Design Spreadsheet is a Microsoft Excel spreadsheet application developed for Design and Review Engineers to show compliance with the stormwater standards. The spreadsheet allows the user to size BMPs in series or in parallel, but is not intended to be used for the complete design of BMPs. A copy of the spreadsheet and tutorial is available from the Drain Commissioner.

### Runoff

The spreadsheet uses the Runoff Curve Number Method to compute runoff volumes by subcatchment. A tabular TR-55 approach is used with a Michigan Unit Hydrograph to compute peak runoff rates. The spreadsheet can be used to calculate the required channel protection volume and the flood control volume for both detention and retention. The Small Storm Hydrology Method is used to calculate the required water quality volume.

The 24-hour rainfall amounts and rainfall distribution specified in Part 4 section “Rainfall” are incorporated into the spreadsheet. Time-of-concentration formulas from TR-55 are also incorporated into the spreadsheet to calculate peak discharges. Output is graphed as hydrographs and summarized in tabular form for a range of rainfall frequencies.

The spreadsheet allows the user to select non-structural and structural BMPs to meet required runoff rates and volumes.

### TSS Accounting

The spreadsheet can be used to calculate the TSS reduction for a series of BMPs. The TSS removal efficiencies for the BMPs provided in [Table 2](#) are used to demonstrate a TSS reduction of 80% or more. When BMPs are used in series (i.e. a treatment train) to achieve the 80% reduction, the TSS removal efficiency of the treatment train is calculated as:

$$e_{TSS} = 1 - (1 - e_1)(1 - e_2) \cdots (1 - e_n) \quad (4.22)$$

where  $e_{TSS}$  is the removal efficiency of the treatment train, and  $e_n$  is the removal efficiency for the  $n^{th}$  BMP in the chain of  $n$  BMPs. This calculation assumes all water entering the treatment train is passed through to the next downstream BMP. The spreadsheet allows the user to calculate TSS reduction when either all or a portion of the water quality volume is passed downstream.

BMPs used for water quality treatment can be classified as retentive or pass-through. Retentive BMPs (e.g. infiltration practice) retain and treat some or all of the water quality volume. Pass-through BMPs (e.g. catchbasin) treat all of the water entering and send this volume to the next BMP or subcatchment.

TSS accounting is done by tracking TSS through the subcatchments. In order to do this, it is assumed that one unit of TSS is the mass of TSS carried by one cubic foot of the water quality volume. The effective removal efficiency is the BMP removal efficiency multiplied by the portion of the water quality volume treated by the BMP. The TSS removed for each BMP is the effective removal efficiency multiplied by the TSS remaining in the treatment train.

The TSS removal efficiency for the subcatchment and/or site is the sum the TSS removed by all BMPs divided by the total TSS to be treated. The released water volume and the TSS remaining are both passed to the next downstream subcatchment.

### Pond Routing

Detention storage volume for flood control is computed by numerically routing the hydrograph for the developed site through a detention basin (pond). The steps in the process are as follows:

1. The inflow hydrograph is interpolated from a collection of scaled hydrographs computed using TR-20 for various times-of-concentration and the ratio of initial abstract to total rainfall (Ia/P) values. This is similar

to the tabular TR-55 approach. The hydrograph collection was generated using the Michigan specific dimensionless unit hydrograph.

2. Structural BMP volumes are removed from the front of the hydrograph, effectively reducing the required flood control volume. The resulting hydrograph does not start until all retention volume is satisfied.
3. The inflow hydrograph adjusted for structural BMPs is routed through a detention pond model using the Modified Puls Method (see Section 8.4.8 of the MDOT Drainage Manual). The pond is assumed to be prismatic and defined by a bottom area, side slope, and orifice diameter. Pond routing is the calculation of the outflow hydrograph given the inflow hydrograph and pond characteristics. This calculation is based on the continuity equation written in differential form:

$$\frac{dV}{dt} = I - Q$$

where  $V$  is the volume of water in storage in the pond at time  $t$ ,  $I$  is the inflow at time  $t$ , and  $Q$  is the outflow at time  $t$ . To calculate the outflow hydrograph, a finite difference method approximation of the continuity equation is used. This allows  $Q$  to be calculated as a time series:

$$\left( V_{i+1} + Q_{i+1} \frac{\Delta t}{2} \right) = (I_{i+1} + I_i - Q_i) \frac{\Delta t}{2} + V_i$$

where  $\Delta t$  is the time step,  $i+1$  refers to the present time and  $i$  refers to a time  $\Delta t$  earlier. At time  $i+1$  everything on the right hand side of the equation is known, allowing the value of the left hand side to be determined. Since  $V$  and  $Q$  are both functions of the pond depth,  $H$ , given the pond characteristics a table

that relates values of pond depth,  $H$ , to values of  $\left( V + Q \frac{\Delta t}{2} \right)$  can be constructed. This table is then used

to find the pond depth at time  $i+1$ . Given this pond depth, the storage volume,  $V$ , and outflow,  $Q$ , can also be computed at time  $i+1$ . The calculation can then proceed to the remaining time steps resulting in the outflow hydrograph.

4. The pond model characteristics include bottom area, side slope, and orifice diameter. The spreadsheet computes the required orifice diameter to produce the desired peak discharge at an arbitrary depth of 5 feet. The sides are conservatively assumed to be vertical.
5. The spreadsheet runs a macro that iteratively adjusts the bottom area until the desired peak discharge and storage depth are met.

### Application

The LGROW Design Spreadsheet can assist the Design Engineer in applying the correct land uses and Curve Numbers in calculating channel protection volume, accounting for travel time through BMPs, accounting for total TSS reduction from a series of BMPs, and quickly evaluating a variety of stormwater management options for a range of rainfall frequencies.

Design calculations submitted using the LGROW Design Spreadsheet can help to expedite the review process because reviewing engineers are familiar with the spreadsheet and can more quickly check for compliance with stormwater standards.

The Stormwater Worksheet is incorporated into the LGROW Design Spreadsheet and need not be submitted separately if the spreadsheet is used.

## I. NON-STRUCTURAL BEST MANAGEMENT PRACTICES

Non-structural BMPs consist of protection measures that reduce the volume of stormwater runoff from the site. This differs from the goal of many structural BMPs which is to help mitigate the impact of stormwater runoff.

Design criteria is provided for the following non-structural BMPs:

- A. Minimal Disturbance Area
- B. Protect Natural Flow Pathways
- C. Protect Sensitive Areas
- D. Native Revegetation
- E. Stormwater Disconnect

Further information and examples are provided in the BMP Fact Sheets in [Chapter 6](#) of the *Low Impact Development Manual for Michigan* (SEMCOG, 2008):

All of the following criteria must be met to receive credit for each non-structural BMP selected for use.

## A. Minimal Disturbance Area

### 1. Summary

Description:	Identify and avoid disturbance to existing pervious areas during construction to reduce potential for erosion and increased runoff.
Application:	Larger sites with pervious areas; difficult to implement on small, high-density developments.
Pretreatment Required:	No.
Maintenance Plan:	Yes, for trees receiving a credit.
Calculation Credits:	
Volume Reduction:	Assign a CN reflecting open space in “good” condition, woods in “good” condition, or a combination.  For small sites, individual trees can receive a credit of 800 square feet per tree, counted as woods in “good” condition. <sup>1</sup>
Rate Reduction:	By virtue of lower CN.
Water Quality:	Exempt from water quality criteria.

<sup>1</sup>Source: *Low Impact Development Manual for Michigan* (SEMCOG, 2008).

*Note:* Trees in minimal disturbance areas receive a larger area credit than trees planted under “Native Revegetation” due to the assumption that the existing trees will typically be larger and more mature than planted trees at the time of site plan submittal and during ensuing years.

### 2. Criteria

This BMP applies to those portions of buildable lots located outside of lot building zones, construction traffic areas, and staging areas that can be maintained as “minimal disturbance areas” during construction (i.e. wooded back portions of residential lots, green space required by ordinance).

Minimal disturbance area – Construction disturbance is limited to clearing of brush and minor grading. No clear-cutting, excavation, filling, stockpiling of material, or construction traffic is allowed. Area is vegetated after disturbance (if any).

- a. Identify minimal disturbance areas on site plan and construction drawings.
- b. Minimal disturbance areas must be protected by having the limits delineated/flagged/fenced in the field. Notes to this effect must be included on construction drawings.
- c. Minimal disturbance areas must not be subject to excessive equipment movement. Vehicle traffic and storage of equipment and/or materials is not permitted.
- d. Pruning or other required maintenance of vegetation is permitted. Additional planting with site-appropriate plants including turf grass is permitted.
- e. Areas receiving credit must be located on the development project.

## B. Protect Natural Flow Pathways

### 1. Summary

Description:	Identify and map natural drainage features to maximize protection and benefits of use.
Application:	Lower-density developments.
Pretreatment Required:	No. This BMP can provide pretreatment.
Maintenance Plan:	Yes.
Calculation Credits:	
Volume Reduction:	Assign a CN reflecting a meadow or open spaces in “good” condition.
Rate Reduction:	Due to longer time-of-concentration for natural flow pathway.
Water Quality:	Exempt from water quality criteria.

### 2. Criteria

- a. Identify all existing natural flow pathways on site plan.
- b. Identify natural flow pathways to be protected on site plan and construction drawings.
- c. Protected natural flow pathways on private property must have an easement or deed restriction to prevent future disturbance or neglect.
- d. Natural flow pathways to be protected must have the limits delineated/flagged/fenced in the field. Notes to this effect must be included on construction drawings.
- e. Identify flow pathways designed as part of the stormwater management system including strategies such as:
  - (1) Increased length.
  - (2) Increased roughness.
  - (3) Decreased slope.
- f. Ensure adequacy of flow pathway for post-development flows.

## C. Protect Sensitive Areas

### 1. Summary

Description:	Identify, map and prioritize sensitive areas on the site to be preserved and protected in perpetuity.
Application:	Plats; Condominiums; More difficult to implement as development density increases.
Pretreatment Required:	No.
Maintenance Plan:	No.
Calculation Credits:	Remove protected sensitive areas from stormwater management calculations, or select an appropriate existing land use if necessary to include the area for sizing of conveyance systems.
Volume Reduction:	Exempt from channel protection criteria.
Rate Reduction:	Exempt from flood control criteria.
Water Quality:	Exempt from water quality criteria.

### 2. Criteria

This BMP includes protected areas on the development property located on separate out lots or set-asides with language in the master deed or bylaws that requires protection and preservation, and that restricts land uses to those that do not increase runoff. For developments involving county drains, a recordable conservation easement in the name of the drainage district must also be provided.

- a. Identify all sensitive areas on site plan.
- b. Identify all sensitive areas to be protected on the site plan and construction drawings.
- c. Sensitive areas to be protected must have the limits delineated/flagged/fenced in the field during construction and visible permanent boundary markers set to minimize encroachment (as appropriate). Notes and details to this effect must be included on construction drawings.
- d. Identify municipal ordinance requirements, if any, and incorporate sensitive area standards for development site. In the absence of a local ordinance, standards for riparian buffers shall consist of:
  - (1) Variable width depending on topography, minimum 25-foot width (Zone 1).
  - (2) Naturally vegetated.
- e. Minimal clearing is allowed for lot access and fire protection.
- f. For activities proposed within floodplains the Developer shall demonstrate any activity proposed within a 100-year floodplain will not diminish the flood storage capacity. Compensatory storage will be required at a minimum ratio of one-to-one (1:1) for all lost floodplain storage.
  - (1) The compensating cut must be available during a flood event.
  - (2) Water must be able to move freely from stream to storage.
  - (3) Excavation must be adjacent to the floodplain.
  - (4) Flood storage must be between the 2-year flood elevation and the 100-year flood elevation.
  - (5) Compensating storage shall NOT be provided through channel widening.



## D. Native Revegetation

### 1. Summary

Description:	Restoration of disturbed pervious areas with deeper-rooted native plants in lieu of conventional turf grass to reduce runoff volume.
Application:	All development types; Limitations where rapid establishment of dense turf grass is needed to prevent erosion in concentrated flow situations.
Pretreatment Required:	No. This BMP can provide pretreatment.
Maintenance Plan:	Yes.
Calculation Credits:	
Volume Reduction:	Assign a CN reflecting a meadow.  For small sites, individual trees can receive a credit of 200 square feet per tree, counted as woods in “good” condition. <sup>1</sup>
Rate Reduction:	By virtue of lower CN.
Water Quality:	Exempt from water quality criteria.

<sup>1</sup>Source: SEMCOG (2008). *Low Impact Development Manual for Michigan*.

*Note:* Trees in minimal disturbance areas receive a larger area credit than trees planted under “Native Revegetation” due to the assumption that the existing trees will typically be larger and more mature than planted trees at the time of site plan submittal and during ensuing years.

### 2. Criteria

- a. Identify native revegetation areas on site plan and construction drawings.
- b. Native revegetation areas must be protected by having the limits delineated/flagged/fenced in the field. Notes to this effect must be included on construction drawings.
- c. Standards shall consist of:
  - (1) Variable width depending on topography, minimum 25-foot width (Zone 1).
  - (2) Native revegetation selected from the *Low Impact Development Manual for Michigan* (SEMCOG, 2008), [Appendix C](#).
- d. Areas receiving credit must be located on the development project.

## E. Stormwater Disconnect

### 1. Summary

Description:	Minimize runoff volume by disconnecting impervious areas from the stormwater conveyance system.										
Application:	Rooftops; Driveways; Walkways; Patio areas; Minor roads.										
Pretreatment Required:	No.										
Maintenance Plan:	Yes.										
Calculation Credits:											
Volume Reduction:	<p>Weight impervious CN with pervious CN for open spaces in “good” condition.</p> <p>The following weighted CNs can be assigned to the disconnected impervious area. They assume a pervious area twice the size of the impervious area.</p> <table border="1"> <thead> <tr> <th>A</th> <th>B</th> <th>C</th> <th>D</th> </tr> </thead> <tbody> <tr> <td>59</td> <td>73</td> <td>82</td> <td>86</td> </tr> </tbody> </table>			A	B	C	D	59	73	82	86
A	B	C	D								
59	73	82	86								
Rate Reduction:	By virtue of weighted CN.										
Water Quality:	Exempt from water quality criteria.										

### 2. Criteria

- a. Stormwater from rooftops and other impervious areas is considered disconnected if it is routed to a stabilized vegetated area or an onsite depression storage area that meets the following criteria:
  - (1) Pervious area is not a structural BMP that must be designed to treat the runoff from the impervious surface.
  - (2) Impervious area must be limited to 1,000 square feet per discharge point.
  - (3) Roof downspouts and curb cuts must be at least 10 feet away from the nearest connected impervious surface to discourage “re-connections.”
  - (4) Disconnection in less permeable soils (HSGs C and D) may require the use of dry wells, french drains, or other temporary storage device to compensate for poor infiltration capability if ponding of water for extended period of time becomes problematic.
  - (5) For disconnects to stabilized vegetated areas:
    - (a.) Size of disconnect area shall be twice the size of the contributing impervious area.
    - (b.) Length of disconnect area must be at least the length of the flow path of the contributing impervious area (maximum 75 feet).
    - (c.) Slope of disconnect area must be no greater than 5%.
    - (d.) Disconnect area may be a “minimal disturbance area.”
  - (6) Disconnection must ensure no basement seepage.
- b. Identify disconnect areas on site plan and construction drawings.

## II. STRUCTURAL BEST MANAGEMENT PRACTICES

Structural BMPs are constructed measures that convey, store and treat stormwater in a site-specific location and help mitigate the impact of stormwater runoff.

Design criteria is provided for the following structural BMPs:

### Conveyance and Storage

- A. Storm Sewer
- B. Culvert or Bridge
- C. Open Channel
- D. Detention Basins
- E. Retention Basins
- F. Sediment Forebay
- G. Spill Containment Cell

### LID and Small Site

- H. Infiltration Practices
- I. Bioretention/Rain Garden
- J. Constructed Filter
- K. Planter Box
- L. Pervious Pavement
- M. Capture Reuse
- N. Vegetated Roof
- O. Water Quality Device
- P. Bioswale and Water Quality Swale
- Q. Vegetated Swale
- R. Vegetated Filter Strip
- S. Level Spreader

BMPs shall be designed in accordance with these standards.

Further information and examples for LID and Small Site BMPs are provided in the BMP Fact Sheets in [Chapter 7](#) the *Low Impact Development Manual for Michigan* (SEMCOG, 2008).

*Note:* Design criteria for BMPs used primarily for soil erosion and sedimentation control and channel stabilization (i.e. riprap, in-stream structures, natural channel design), and technical specifications for construction are beyond the scope of this manual.

## A. Storm Sewer

### 1. Summary

Description:	Provides stormwater conveyance in an enclosed system.
Application:	Urban areas; Where above-ground conveyance is not desirable.
Types:	Pipe (solid wall, perforated).
Pretreatment Required:	No. This BMP can provide spill containment.
Maintenance Plan:	Yes.
Calculation Credits:	
Volume Reduction:	Solid wall pipe: None. Perforated pipe (with slope): None.
Rate Reduction:	None.
Water Quality:	Count volume routed through catch basin.

### 2. Design Requirements

#### a. Sizing and Configuration

- (1) Storm sewer shall be designed to convey the peak discharge from a 10-year rainfall event. Surcharging of the storm sewer during the 10-year rainfall event will not be permitted. Surcharging of the pipe may be allowed up to the 25-year rainfall event to a level 1 foot below the top of casting.
- (2) A dual or redundant storm sewer may be required to convey the peak discharge from a 100-year rainfall event if acceptable overland flow routes do not exist (refer to Part 3 section "Flood Control").
- (3) Design velocities, capacities, and friction losses shall be based on Manning's equation:

$$Q = \frac{1.49AR^{\frac{2}{3}}S^{\frac{1}{2}}}{n} \quad (4.23)$$

where:

$Q$  = discharge (cubic feet per second)

$A$  = wetted area (square feet)

$R$  = hydraulic radius (feet)

$S$  = slope (feet per foot)

$n$  = Manning's roughness coefficient

- (4) Manning's coefficients for closed conduit are included in **Table 12**.
- (5) Acceptable slopes for circular pipe ("n" = 0.013) are included in **Table 13**. Minimum and maximum grade for other Manning's n values must be calculated based on allowable minimum and maximum velocities (V).
- (6) Entrance and exit losses in manholes, catchbasins, and at inlets and outlets shall be accounted for when determining the hydraulic grade line. Each entrance and exit loss shall be equal to at least  $\frac{1}{2}$  the velocity head ( $H_v$ ) where:  $H_v = V^2 / 2g$
- (7) Storm sewer pipe shall have a minimum diameter of 12 inches. Smaller pipe may be approved for private systems.
- (8) The minimum depth of cover shall be 24 inches from grade to the top of pipe.
- (9) Restricted conveyance systems designed to create backflow into storm water storage facilities are not permitted. A storm sewer line shall not be used as both an inlet and outlet line to a storm water storage facility.

**Table 12 – Manning’s Roughness Coefficients**

Conduit	Coefficients
<b>Closed Conduits</b>	
Asbestos-Cement Pipe	0.011 to 0.015
Brick	0.013 to 0.017
Cast Iron Pipe (Cement-lined and seal-coated)	0.011 to 0.015
Concrete (Monolithic)	
Smooth forms	0.012 to 0.014
Rough forms	0.015 to 0.017
Concrete Pipe	0.011 to 0.015
Corrugated-Metal Pipe (1/2-inch corrugated)	0.022 to 0.026
Paved invert	0.018 to 0.022
Spun asphalt-lined	0.011 to 0.015
Plastic Pipe (Smooth)	0.011 to 0.015
Vitrified Clay Pipes	0.011 to 0.015
Liner channels	0.013 to 0.017
<b>Open Channels</b>	
Lined Channels	
Asphalt	0.013 to 0.017
Brick	0.012 to 0.018
Concrete	0.011 to 0.020
Rubble or riprap	0.020 to 0.035
Vegetal	0.030 to 0.040
Excavated or Dredged	
Earth, straight and uniform	0.020 to 0.030
Earth, winding, fairly uniform	0.025 to 0.040
Rock	0.030 to 0.045
Unmaintained	0.050 to 0.140
Natural Channels (streams, top width at flood state <100 feet)	
Fairly regular section	0.030 to 0.070
Irregular section with pools	0.040 to 0.100
Source: American Society of Civil Engineers and the Water Pollution Control Federation (1969). <i>Design and Construction of Sanitary and Storm Sewers</i> .	

**Table 13 – Minimum and Maximum Slopes for Storm Sewers**

Pipe Size (inches)	Minimum % of Grade (Velocity = 2.5 feet per second)	Maximum % of Grade (Velocity = 10 feet per second)
12	0.32	4.88
15	0.24	3.62
18	0.20	2.84
21	0.16	2.30
24	0.14	1.94
27	0.12	1.66
30	0.10	1.44
36	0.08	1.12
42	0.06	0.92
48	0.06	0.76
54	0.04	0.60
60	0.04	0.54
66	0.04	0.48
Manning’s “n” = 0.013		

## b. End Treatment

- (1) Outlet pipes shall require energy dissipation. Riprap protection or equivalent erosion control measures shall be used where the velocity exceeds 4 feet per second, up to maximum allowable design velocity of 8 feet per second.
- (2) Outlets into open channels or grassed swales shall enter at an angle of 90 degrees or less with the direction of flow.

## c. Manholes and Catch Basins

- (1) Manhole spacing shall not exceed 400 feet for sewers less than 42 inches in diameter and 600 feet for larger sewers.
- (2) Manholes shall be placed at all changes in pipe direction, slope, pipe size, all inlet connection locations, and at the upper end of the storm sewer.
- (3) Where possible, pipe inverts at junctions shall be designed to minimize junction losses (match 0.8 points of pipe diameters).
- (4) Minimum inside diameter of all manholes, catch basins, and inlet structures shall be 48 inches, except that a 24-inch diameter structure may be allowed with a single 12-inch outlet pipe.
- (5) All structures receiving direct surface water runoff shall have a sump not less than 24 inches deep.
- (6) Catch basins shall be placed at low points of streets and yards. Spacing and/or number of inlet structures required to accommodate the design flows in streets, private drives, and parking areas shall be provided based on inlet capacity with no ponding occurring during a 10-year storm, and the following additional stipulations:
  - (a.) No more than 300 feet of pavement surface drainage will be allowed. No more than 200 feet of surface drainage will be allowed for grades exceeding 4%.
  - (b.) Consideration shall be given to pedestrian crossings when siting catchbasins in intersections. Catchbasins shall be placed upstream of pedestrian crossings when practical.
  - (c.) No more than 150 feet of street drainage will be allowed to flow around a corner.
  - (d.) No flow will be allowed across a public street intersection.

## d. Sump Discharge

- (1) Sump discharge outlets for individual lots shall be a catchbasin (minimum 4-foot diameter) with lead (6-inch minimum diameter); manufactured tees; or cored and booted lead.

## e. Rear Lot Drainage

- (1) Lots with rear lot drainage shall have an underdrain.
- (2) Minimum diameter of rear lot catchbasin shall be 2 feet.
- (3) Minimum pipe diameter and slope by drainage area:

Drainage Area (acre)	Minimum Pipe Diameter (inches)	Slope
≤ 0.5 acre	6	0.5%
≥ 0.5 acre; ≤ 1 acre	8	0.3%
> 1 acre	mainline storm sewer	Table 13

## f. Materials

- (1) All materials must comply with the authority having jurisdiction over the storm sewer system.
- (2) Storm sewer pipe within the influence of a public road shall be reinforced concrete pipe. All other storm sewer pipe shall be reinforced concrete or smooth interior wall polyethylene in accordance with MDOT Standard Specifications. Other materials shall be subject to approval.
- (3) Pipe joints shall be designed to prevent excessive infiltration or exfiltration.
- (4) Manholes and catch basins shall be in accordance with MDOT Standard Specifications.

## B. Culvert or Bridge

### 1. Summary

Description:	Provides stormwater conveyance through a crossing structure.
Application:	Where crossing of open channels, wetlands, waterbodies, and grassed swales is required. Culverts can also provide equalization and outlet control.
Types:	Pipe Culvert; Box Culvert; Bridge.
Pretreatment Required:	No.
Maintenance Plan:	Yes.
Calculation Credits:	
Volume Reduction:	None.
Rate Reduction:	None.
Water Quality:	None.

### 2. Design Requirements

#### a. Sizing and Configuration

- (1) Bridges shall be designed to provide a 4.3-foot minimum underclearance at normal flow for canoe traffic on navigable waterways, and a 2-foot minimum freeboard to the underside (low chord) of the bridge for a 100-year flood where conditions allow.
- (2) Footings shall extend at least 4 feet below the bottom of the channel, and shall be designed such that channel maintenance will not cause failure of the bridge or culvert.
- (3) Culverts serving a drainage area of less than 2 square miles shall be designed for the 25-year peak discharge in the developed watershed with a maximum outlet velocity of 8 feet per second. A maximum of 1 foot of inlet submergence may be permitted if this does not backup water out of the easement.
- (4) The effect of the 100-year storm shall be reviewed to ensure no adverse increase in water elevation off of the development property or flooding of structures within the development.
- (5) Sizing of culverts and bridges shall be performed using the Bernoulli Equation and include consideration of inlet and outlet control, entrance and exit losses, and tailwater condition. Published culvert nomographs and other computer software may be used.
- (6) Minimum diameter of a drive culvert shall be 12 inches.
- (7) Minimum diameter of a road crossing culvert shall be 18 inches or equivalent pipe arch.

#### b. End Treatment

- (1) Headwalls, wingwalls, and all other end treatments shall be designed to ensure the stability of the surrounding soil. MDOT, County Road Commission, or manufacturer's designs may be used.
- (2) Riprap protection or equivalent erosion control measures shall be used where the velocity exceeds 4 feet per second, up to maximum allowable design velocity of 8 feet per second.

#### c. Materials

- (1) All materials must comply with the authority having jurisdiction over the roadway.
- (2) Culverts may be reinforced concrete pipe, corrugated steel pipe, or pipe arch in accordance with Road Commission or MDOT Standard Specifications. Smooth interior wall polyethylene may also be allowed.

## C. Open Channel

### 1. Summary

Description:	Stormwater conveyance in an excavated channel.
Application:	Larger drainage areas with concentrated runoff.
Types:	Channel; Ditch.
Pretreatment Required:	No.
Maintenance Plan:	Yes.
Calculation Credits:	
Volume Reduction:	None.
Rate Reduction:	None.
Water Quality:	None.

### 2. Design Requirements

#### a. Sizing and Configuration

- (1) The open channel shall be designed to convey the 25-year peak discharge.
- (2) Open channel design velocities, capacities, and friction losses shall be based on Manning's equation:

$$Q = \frac{1.49AR^{\frac{2}{3}}S^{\frac{1}{2}}}{n} \quad (4.23)$$

where:

- $Q$  = discharge (cubic feet per second)
- $A$  = wetted area (square feet)
- $R$  = hydraulic radius (feet)
- $S$  = slope (feet per foot)
- $n$  = Manning's roughness coefficient

- (3) Manning's Coefficients shall be determined from **Table 12**. A minimum Manning's Coefficient of 0.035 shall be used for open channels, unless special treatment is given to the bottom and sides (riprap, paving, mown sod, etc.).
- (4) Minimum bottom width shall be 2 feet.
- (5) Minimum longitudinal slope shall be 0.10%.
- (6) Side slopes shall be no steeper than 2:1 (horizontal to vertical).
- (7) The minimum velocity for open channels during the design event shall be 1.5 feet per second.
- (8) The maximum velocity shall be 4 feet per second. Riprap protection or equivalent shall be used where the velocity exceeds 4 feet per second, up to maximum allowable design velocity of 8 feet per second.

#### b. Connections and Crossings

- (1) Outlets into the open channel shall enter at an angle of 90 degrees or less with the direction of flow.
- (2) A minimum clearance of 5 feet is required between open channel inverts and underground utilities unless special provisions are approved.



## D. Detention Basins

### 1. Summary

Description:	Provides stormwater storage with a surface outlet.
Application:	Practical for a wide range of applications including large sites.
Types:	Dry Basin; Underground Vault; Extended Detention Basin; Wet Pond; Constructed Wetland.
Pretreatment Required:	Yes, may be needed to meet TSS removal, facilitate maintenance, or preserve intended aesthetics of basin.
Maintenance Plan:	Yes.
Calculation Credits:	
Volume Reduction:	None.
Rate Reduction:	Calculated release rate.
Water Quality:	Count volume routed through BMP.

### 2. Sizing Calculations

- a. Calculate the allowable release rate and the required storage volume for flood control (refer to Part 4 section “Calculating Storage Volumes and Release Rates, Flood Control, Detention”).
- b. Extended detention volume provided for water quality treatment and/or channel protection may be included in the flood control volume if it comprises no more than 30% of the flood control volume. Where channel protection and water quality treatment are provided through upstream retention BMPs, these volumes may be subtracted from the total inflow volume.
- c. Size forebay(s) for pretreatment (refer to Part 4 section “Calculating Storage Volumes and Release Rates, Pretreatment”).
- d. Detention basins without an acceptable surface water overflow route shall be designed for 2 times the required flood control volume.

### 3. Design Requirements

- a. Siting
  - (1) Soil borings are required (refer to Part 4 section “Soils Investigation”).
    - (a.) A minimum of 2 feet is required between the bottom of dry detention basins and the highest known groundwater elevation.
    - (b.) Wet ponds and constructed wetlands shall have a reliable supply of baseflow or groundwater to support a permanent pool.
    - (c.) A constructed wetland must have a minimum contributing drainage area of 10 acres (5 acres for a pocket wetland).
    - (d.) Wet ponds and constructed wetlands proposed in HSG A and HSG B soils above the groundwater table shall have a clay or synthetic liner to minimize infiltration.

- (2) Setbacks shall be as follows:
  - (a.) Public and private sidewalk/non-motorized pathway: 5 feet
  - (b.) Adjacent property line: 10 feet
  - (c.) Building foundation: 30 feet
  - (d.) Private well: 50 feet
  - (e.) Public well: 200 feet from Type I or Type IIa wells, 75 feet from Type IIb or Type III wells (Safe Drinking Water Act, Act 399, PA 1976)
  - (f.) Septic system drainfield: 100 feet
  - (g.) Airport: Per Federal Aviation Administration guidelines (wet pond, constructed wetland)
- b. Configuration
  - (1) General
    - (a.) Distances of flow paths between inlets and outlets shall be maximized. A minimum basin length-to-width ratio of 2 to 1 is required.
    - (b.) If site constraints preclude placing pipes at opposite ends of the basin or meeting the length-to-width ratio, baffles (berms) may be used to lengthen the flow path.
    - (c.) Where steeper side slopes than those specified are unavoidable, safety railing, fencing, or other access barriers may be approved.
  - (2) Dry Basin
    - (a.) The design high water depth should generally not exceed 10 feet above the bottom of the basin.
    - (b.) Side slopes shall not be steeper than 4:1 (H:V). Where basins are to be maintained as a mown lawn, side slopes shall be no steeper than 5:1 (H:V) to facilitate mowing.
    - (c.) The bottom of dry detention basins shall be graded to provide positive flow to the pipe outlet. A minimum longitudinal bottom slope of 1% shall be provided. Cross slopes shall be 2% minimum. If continuous flow is anticipated, a low-flow channel shall be provided, with necessary crossings, and sloped to eliminate standing water. If site grades prohibit achieving these minimum slopes, the use of an underdrain with flatter slopes may be approved.
  - (3) Wet Pond
    - (a.) At a minimum, the volume of the permanent pool for wet ponds shall be 2.5 times the water quality volume to account for reduced settling efficiency due to turbulence caused by wind.
    - (b.) Wet ponds shall generally be wedge-shaped with inflow at the narrow end to prevent short-circuiting and stagnation. However, other shapes meeting the design intent may be approved.
    - (c.) Permanent pools shall have a minimum depth of 3 feet across the deepest part of the basin to discourage aquatic plant infill and provide open water.
    - (d.) The design high water depth should generally not exceed 10 feet above the permanent pool elevation.
    - (e.) Side slopes shall not be steeper than 4:1 (H:V). Where basins are to be maintained as a mown lawn to the water's edge, side slopes shall be no steeper than 5:1 (H:V) to facilitate mowing.
    - (f.) A minimum 8-foot wide safety bench shall be constructed on the slopes of wet ponds with a permanent pool 3 feet or deeper. The safety bench shall have a maximum slope of 6:1 (H:V) and extend a minimum of 8 inches below the permanent pool level and a minimum of 8 inches above the permanent pool level.
    - (g.) Warning signs prohibiting swimming and skating shall be posted for wet ponds.
    - (h.) Ponds exceeding 5 acres in size and 6 feet in structural height will not be permitted unless a permit is first issued by DEQ Dam Safety Unit pursuant to Part 315, Act 451, PA 1994.

## (4) Constructed Wetland

- (a.) The emergent vegetation zone shall comprise 60 to 65% of the total surface area. Half shall be high marsh with a normal water depth of 6 inches or less, and half shall be low marsh with a normal water depth between 6 and 18 inches.
- (b.) The open water zone shall comprise 35% to 40% of the total surface area with a normal water depth of between 18 inches and 6 feet.
- (c.) At a minimum, the volume of the permanent pool for the open water zone shall be 2.5 times the water quality volume to account for reduced settling efficiency due to turbulence caused by wind.
- (d.) The design high water surface elevation shall not exceed the normal water surface elevation by more than 4 feet.
- (e.) Side slopes shall be 4:1 to 5:1 (H:V) wherever possible. Side slopes shall not be steeper than 3:1 (H:V).
- (f.) A minimum 8-foot wide safety bench shall be constructed on the slopes of constructed wetlands with a permanent pool 3 feet or deeper. The safety bench shall have a maximum slope of 6:1 (H:V) and extend a minimum of 8 inches below the permanent pool level and a minimum of 8 inches above the permanent pool level.
- (g.) A micro pool shall be located at the outlet of the stormwater wetland to protect the low flow pipe from clogging and prevent sediment resuspension. The micro pool shall be 3 to 6 feet deep and have a minimum surface area equivalent to the forebay.
- (h.) A pocket wetland shall consist of a forebay and micropool with safety benches.

## c. Inlet Design

- (1) Inlet pipes shall not be fully submerged at normal pool elevations.
- (2) Inlet pipes shall require energy dissipation. Riprap protection or equivalent erosion control measures shall be used where the velocity exceeds 4 feet per second up to maximum allowable design velocity of 8 feet per second.
- (3) Pretreatment shall be provided in a sediment forebay, spill containment cell, or water quality swale. For small sites, a water quality device may be used prior to the basin. Pretreatment for overland sheet flow entering the basin can be provided through a vegetated filter strip.
- (4) When spill containment is required, all pipes contributing runoff from the high risk area must enter the pretreatment BMP.

## d. Outlet Design

- (1) The outlet shall consist of a multi-stage outlet and include a low flow orifice or multiple orifice openings, a primary overflow (typically provided through the top of a grated riser pipe), and a secondary emergency overflow spillway.
- (2) Staged low flow outlet: When required, the lowest stage openings shall be sized to accommodate the water quality or channel protection volume. The flood control opening shall be placed at the resulting high water level, and sized so that the cumulative discharge from all openings is limited to the maximum allowable design discharge at the design high water level.

## (3) Low Flow Outlet

- (a.) The low flow outlet may be designed using the orifice equation, rearranged to solve for area:

$$A = \frac{Q}{c \sqrt{2gH}} \quad (4.24)$$

where:

- $A$  = required area (square feet)  
 $Q$  = required outflow (cubic feet per second)  
 $c$  = orifice coefficient (approximately 0.6)  
 $2g$  = 2 times the gravitation constant ( $g = 32.2$  feet per second)  
 $H$  = height of design high water level above center of orifice outlet (feet)

- (b.) Other types of outlet devices shall have full design calculations provided for review.
- (c.) The outlet shall be designed to prevent clogging and be accessible for maintenance.
- (d.) Pipes or orifice plates shall have a minimum diameter of 4 inches without additional protection against clogging.
- (e.) Pipe or orifice openings less than 4 inches in diameter shall be protected from clogging by directing inflow through a sufficiently large opening area protected with a properly-sized filter or screen prior to the orifice.
- (f.) A gravel filtration jacket consisting of 3-inch washed stone and 1-inch washed stone must be placed around all perforated riser pipes in basins, wet ponds and constructed wetlands. The orifice configuration must be wrapped with hard wire mesh with an appropriate opening size to prevent any stone from passing through the orifice. The 3-inch stone must be placed immediately adjacent to the riser pipe with the 1-inch stone covering the larger stone. The gravel jacket must extend sufficiently above all orifice patterns.
- (g.) Orifices used to maintain a permanent pool shall be designed to withdraw water a minimum of 2 feet below the normal water surface.

## (4) Primary Overflow

- (a.) All detention basins must have a primary overflow at the design high water level.
- (b.) The primary overflow shall be designed to convey the 10-year undetained peak inflow at the maximum design high water level. The depth of water at the crest of the secondary emergency overflow is the maximum design high water level.
- (c.) The downstream outlet pipe shall be designed to convey the 10-year undetained peak inflow from the primary overflow and the discharge from the low flow orifice(s) at the maximum design high water level.
- (d.) Hoods and trash racks shall be placed on riser pipes. Grate openings shall be a maximum of 3 inches on center. A vertical flow area must be provided where leaves and debris are prone to clog a horizontally seated grate.
- (e.) Riser pipes shall have a minimum diameter of 24 inches. Riser pipes greater than 4 feet in height shall be a minimum of 48 inches in diameter.
- (f.) Riser pipes shall be constructed of reinforced concrete or corrugated metal and be set in a concrete base designed to prevent buoyancy. Plastic is not acceptable as a material unless riser is buried, due to lack of durability.

- (g.) The riser must be placed near or within the embankment to provide for ready maintenance access.
- (h.) When possible, a drain for completely dewatering the detention basin shall be installed for maintenance purposes.
- (i.) Pipes placed through embankments shall have anti-seep collars.
- (j.) Outlet pipes shall require energy dissipation. Riprap protection or equivalent erosion control measures shall be used where the velocity exceeds 4 feet per second up to maximum allowable design velocity of 8 feet per second.

(5) Secondary Emergency Overflow Spillway

- (a.) All detention basins must have a provision for emergency overflow (i.e. a spillway).
- (b.) The spillway shall be designed for the 100-year undetained peak inflow with a maximum flow depth of 1 foot. The spillway shall be sized using the weir equation:

$$\text{Rectangular weir:} \quad Q = CLH^{\frac{3}{2}} \quad (4.25)$$

$$\text{Trapezoidal weir:} \quad Q = 0.75CmH^{2.5} + CLH^{\frac{3}{2}} \quad (4.26)$$

$$\text{Triangular weir:} \quad Q = 0.75CmH^{2.5} \quad (4.27)$$

where:

- $Q$  = discharge (cubic feet per second)
- $C$  = coefficient of discharge (varies from 2.6 to 3.3)
- $m$  = Side slope (i.e.  $m=3$  for 1v:3h side slope)
- $L$  = length of spillway crest (feet)
- $H$  = total head measured above spillway crest (feet)

- (c.) Freeboard. The top of berm elevation shall be a minimum of 0.5 foot above the design flow depth over the spillway. In no case shall the spillway depth (distance between spillway crest and top of berm) be less than 1 foot.
  - (d.) Overflow spillways shall be protected with concrete, riprap or a permanent erosion control blanket (preferred) to prevent erosion of the structure. Protection shall extend across the entire spillway up to the top of berm, start on the basin side a minimum of 3 feet below the spillway crest and extend down the spillway to an apron a minimum of 6 feet beyond the toe of the spillway.
- e. Access
- (1) Outlet control structures shall be placed near or within the embankment to facilitate maintenance access.
  - (2) Berm top width shall be a minimum of 4 feet, or 12 feet where vehicle access is required.
  - (3) A minimum 10-foot wide maintenance access route from a public or private right-of-way shall be provided to the basin. The access way (including side slopes on trapezoidal and triangular spillways) shall have a vertical grade of no greater than 16.7% (6:1 H:V slope) and shall be stabilized to withstand the passage of heavy equipment. Direct access to the forebay, control structures and the outlet shall be provided.

4. Design Schematics

**DRY DETENTION BASIN**

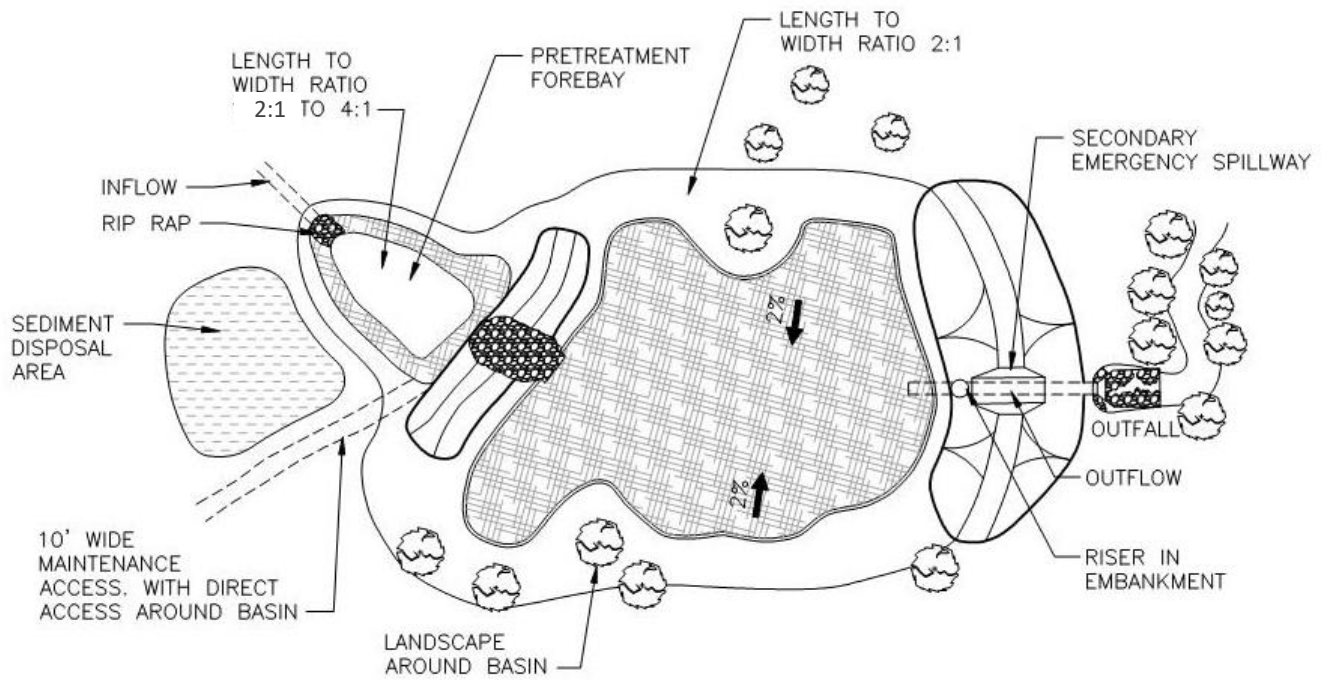

**PLAN VIEW**

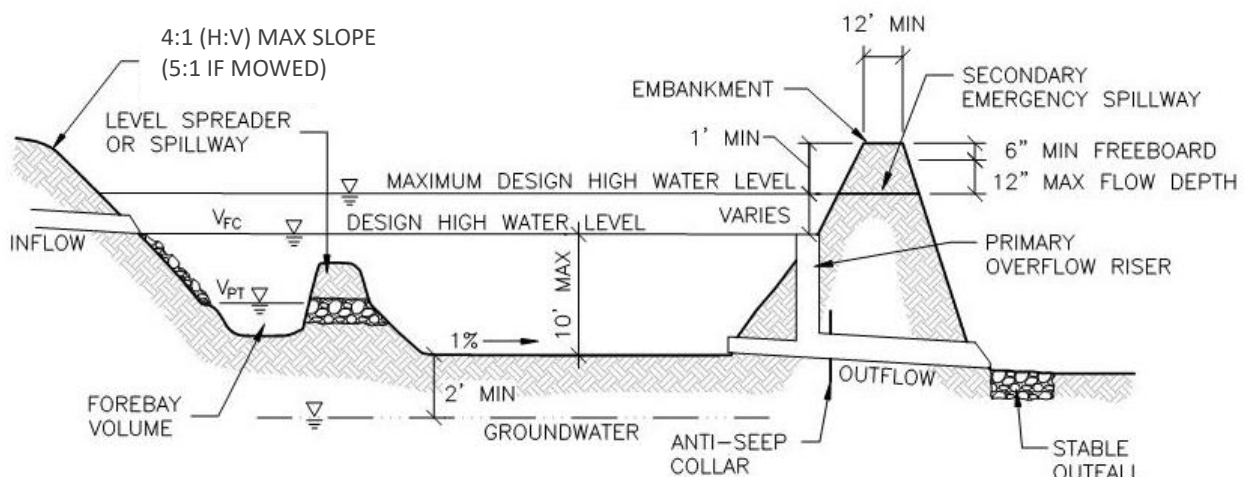

**PROFILE**

FINAL OUTLET CONFIGURATION MUST BE DESIGNED TO PREVENT CLOGGING

# EXTENDED DETENTION BASIN

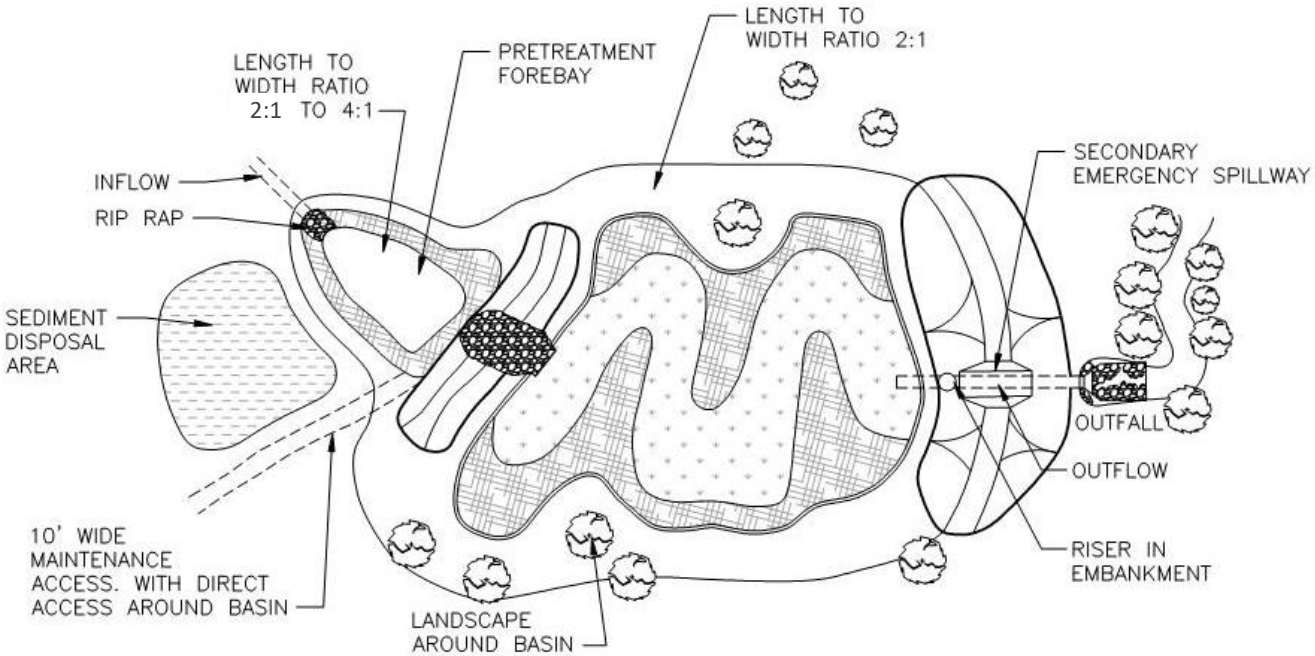

**PLAN VIEW**

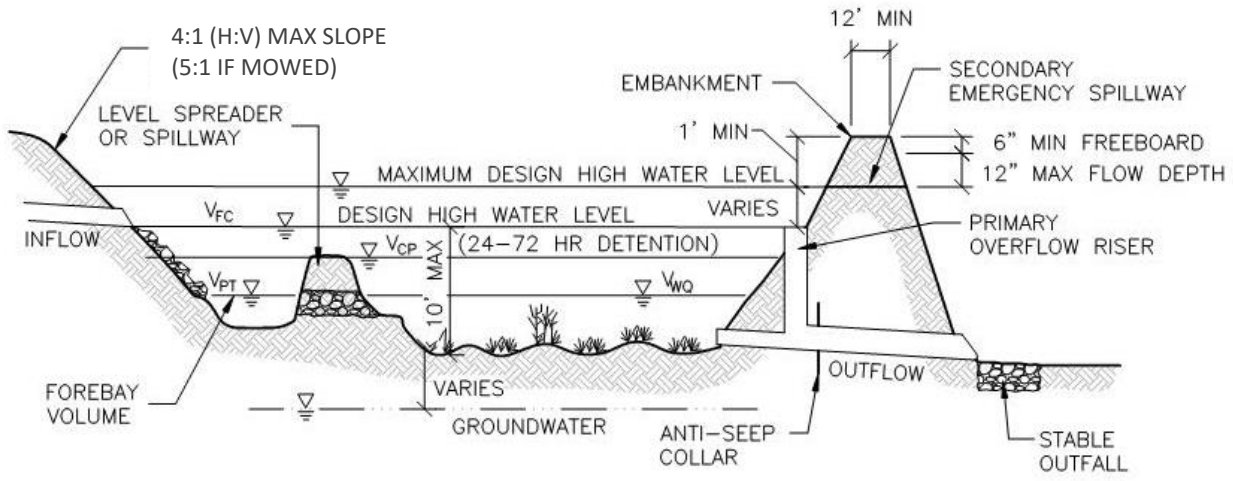

**PROFILE**

FINAL OUTLET CONFIGURATION MUST BE DESIGNED TO PREVENT CLOGGING

## WET DETENTION BASIN (WET POND)

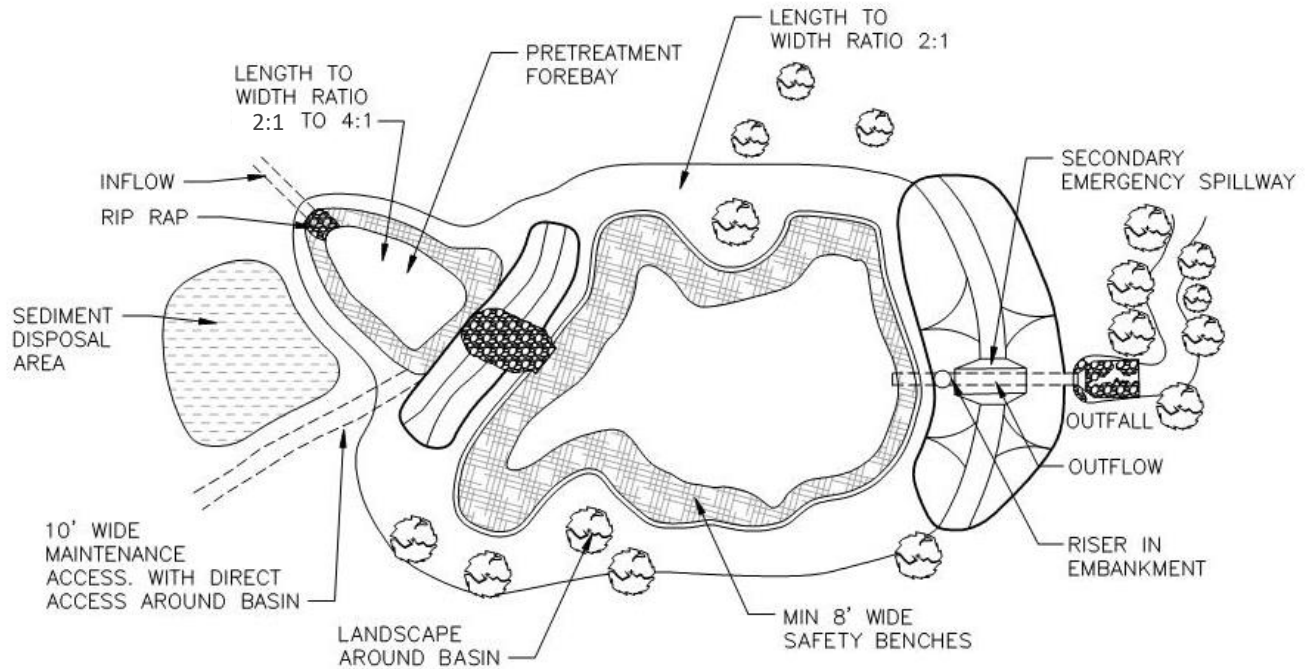

**PLAN VIEW**

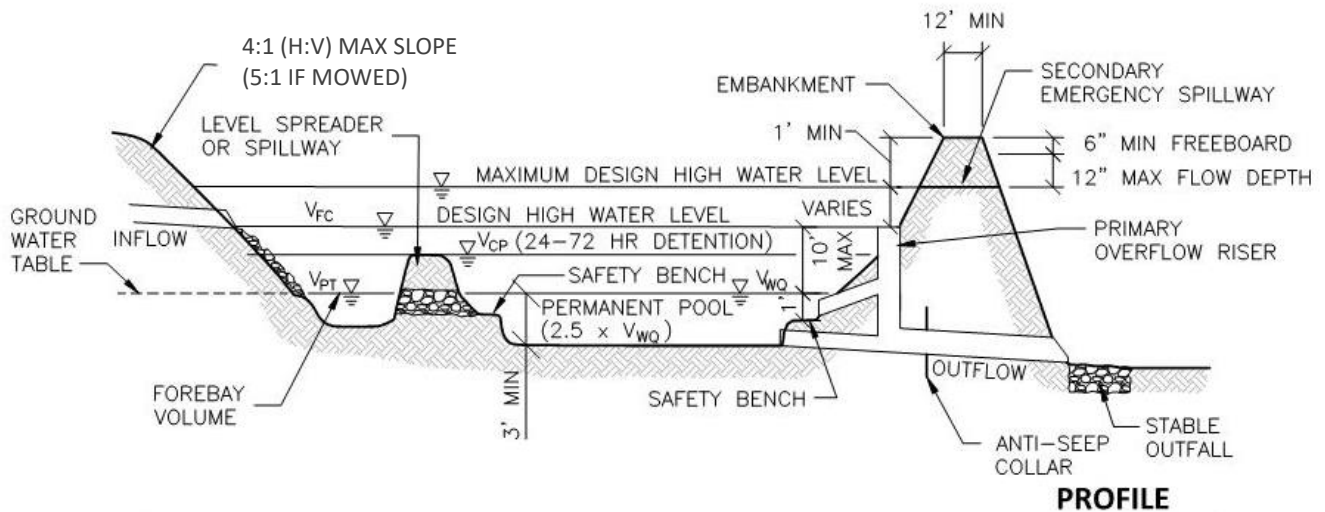

**PROFILE**

FINAL OUTLET CONFIGURATION MUST BE DESIGNED TO PREVENT CLOGGING



## CONSTRUCTED WETLAND

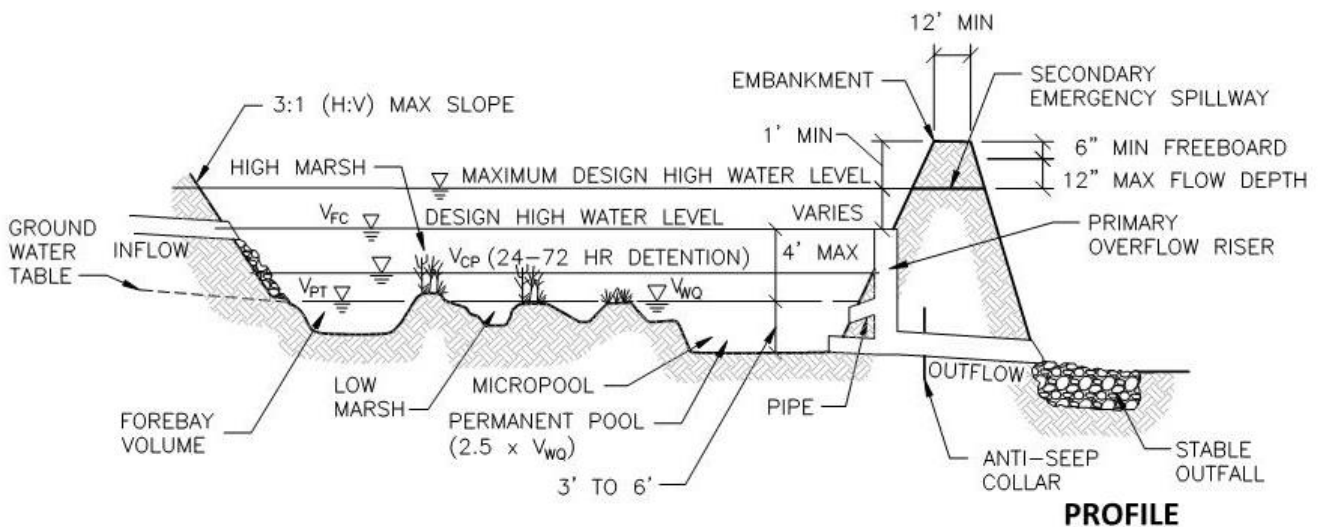
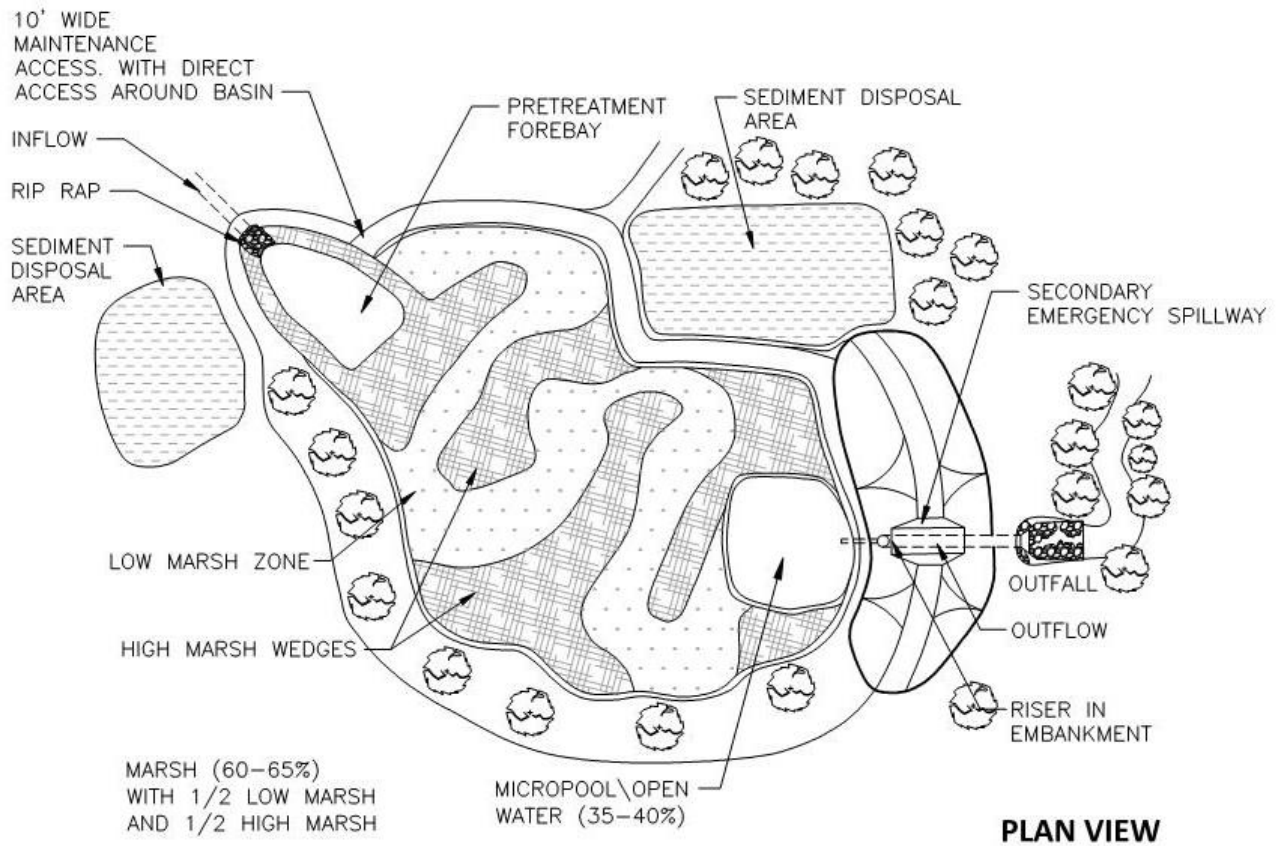

FINAL OUTLET CONFIGURATION MUST BE DESIGNED TO PREVENT CLOGGING

## E. Retention Basins

### 1. Summary

Description:	Provides stormwater storage without a surface outlet.
Application:	Practical for a wide range of applications including large sites. Not recommended for regional use without supplemental measures and provisions for a positive outlet.
Types:	Dry Basin; Wet Pond.
Pretreatment Required:	Yes.
Maintenance Plan:	Yes.
Calculation Credits:	
Volume Reduction:	Count volume stored and infiltrated.
Rate Reduction:	Designed for flood control: 100%.
Water Quality:	Count volume stored and infiltrated.

### 2. Sizing Calculations

- Calculate the required storage volume for flood control (refer to Part 4 section “Calculating Storage Volumes and Release Rates, Flood Control, Retention”).
- Calculate the minimum infiltration area required to drain the required storage volume in the specified drawdown time using the design infiltration rate (refer to Part 4 section “Design Infiltration Rates”).

$$A = \frac{12V_s}{i(t_d)} \quad (4.28)$$

where:

- A = minimum infiltration area (square feet)
- V<sub>s</sub> = storage volume (cubic feet)
- i = design infiltration rate (inches per hour)
- t<sub>d</sub> = maximum allowable drawdown time (hours)
- 12 factor to convert inches to feet

- Drawdown time shall be no more than 72 hours.
- The infiltration area shall be defined as the bottom of the basin, or the horizontal projection of the side slopes up to half of the design water depth above a permanent pool.
- Where channel protection and water quality treatment are provided through upstream retention BMPs, these volumes may be subtracted from the total inflow volume. If provided in the same retention basin, channel protection and water quality volumes are included in the flood control volume.
- Pretreatment: Size forebay(s) for the pretreatment volume (refer to Part 4 section “Calculating Storage Volumes and Release Rates”). Regional retention basins will require spill containment, forebays sized for the full water quality volume, and may require other measures to reduce the potential for groundwater contamination and protect the infiltration capacity of the BMP.
- Retention basins without an acceptable surface water overflow route shall be designed for 2 times the required flood control volume.

### 3. Design Requirements

- a. Siting
  - (1) Soil borings are required (refer to Part 4 section “Soils Investigation”).
    - (a.) A minimum of 3 feet is required between the bottom of dry retention basins and the highest known groundwater elevation.
  - (2) Setbacks shall be as follows:
    - (a.) Public and private sidewalk/non-motorized pathway: 5 feet
    - (b.) Adjacent property line: 10 feet
    - (c.) Building foundation: 30 feet
    - (d.) Private well: 50 feet
    - (e.) Public well: 200 feet from Type I or Type IIa wells, 75 feet from Type IIb or Type III wells (Safe Drinking Water Act, Act 399, PA 1976)
    - (f.) Septic system drainfield: 100 feet
    - (g.) Airports: Per Federal Aviation Administration guidelines (wet ponds)
  - (3) Perform groundwater mounding calculations to ensure no adverse impacts to adjacent structures.
- b. Configuration
  - (1) General
    - (a.) Where steeper side slopes than those specified are unavoidable, safety railing, fencing or other access barriers may be approved.
  - (2) Dry Basin
    - (a.) The design high water depth should generally not exceed 7 feet above the bottom of the basin.
    - (b.) Side slopes shall not be steeper than 4:1 (H:V). Where basins are to be maintained as a mown lawn, side slopes shall be no steeper than 5:1 (H:V) to facilitate mowing.
    - (c.) The bottom of dry retention basins shall be flat to encourage uniform ponding and infiltration.
  - (3) Wet Pond (no surface water outlet)
    - (a.) The design high water depth should generally not exceed 7 feet above the permanent pool elevation.
    - (b.) Where excavation and reshaping of the retention area is necessary, side slopes shall not be steeper than 4:1 (H:V). Where basins are to be maintained as a mown lawn to the water’s edge, side slopes shall be no steeper than 5:1 (H:V) to facilitate mowing.
    - (c.) A minimum 8-foot wide safety bench shall be constructed on the slopes of wet ponds with a permanent pool 3 feet or deeper. The safety bench shall have a maximum slope of 6:1 (H:V) and extend a minimum of 8 inches below the permanent pool level and a minimum of 8 inches above the permanent pool level.
    - (d.) Warning signs prohibiting swimming and skating shall be posted for wet ponds.
- c. Inlet Design
  - (1) Inlet pipes shall not be fully submerged at normal pool elevations.
  - (2) Inlet pipes shall require energy dissipation. Riprap protection or equivalent erosion control measures shall be used where the velocity exceeds 4 feet per second, up to maximum allowable design velocity of 8 feet per second.

- (3) Pretreatment is required for each inlet and shall be provided in a sediment forebay, spill containment cell, or water quality swale. For small sites, a water quality device with an 80% or greater TSS removal efficiency may be used prior to the basin. Pretreatment for overland sheet flow entering the basin can be provided through a vegetated filter strip.
- (4) When spill containment is required, all pipes contributing runoff from the high risk area must enter this pretreatment BMP.

d. Overflow

(1) Primary Overflow

- (a.) When possible, retention basins must have a primary overflow at the design high water level.
- (b.) The primary overflow and downstream pipe shall be designed to convey the 10-year undetained peak inflow at the maximum design high water level. The depth of water at the crest of the secondary emergency overflow is the maximum design high water level.
- (c.) Hoods and trash racks shall be placed on riser pipes. Grate openings shall be a maximum of 3 inches on center. A vertical flow area must be provided where leaves and debris are prone to clog a horizontally seated grate.
- (d.) Riser pipes shall have a minimum diameter of 24 inches. Riser pipes greater than 4 feet in height shall be a minimum of 48 inches in diameter.
- (e.) Riser pipes shall be constructed of reinforced concrete or corrugated metal and be set in a concrete base designed to prevent buoyancy. Plastic is not acceptable as a material unless riser is buried, due to lack of durability.
- (f.) When possible, a drain for completely dewatering the retention basin shall be installed for maintenance purposes.
- (g.) Pipes placed through embankments shall have anti-seep collars.
- (h.) Outlet pipes shall require energy dissipation. Riprap protection or equivalent erosion control measures shall be used where the velocity exceeds 4 feet per second up to maximum allowable design velocity of 8 feet per second.

(2) Secondary Emergency Overflow Spillway

- (a.) All retention basins must have a provision for emergency overflow (i.e. a spillway).
- (b.) The spillway shall be designed for the 100-year undetained peak inflow with a maximum flow depth of 1 foot. The spillway shall be sized using the weir equation:

$$\text{Rectangular weir: } Q = CLH^{\frac{3}{2}} \quad (4.25)$$

$$\text{Trapezoidal weir: } Q = 0.75CmH^{2.5} + CLH^{\frac{3}{2}} \quad (4.26)$$

$$\text{Triangular weir: } Q = 0.75CmH^{2.5} \quad (4.27)$$

where:

- $Q$  = discharge (cubic feet per second)
- $C$  = coefficient of discharge (varies from 2.6 to 3.3)
- $m$  = Side slope (i.e.  $m=3$  for 1v:3h side slope)
- $L$  = length of spillway crest (feet)
- $H$  = total head measured above spillway crest (feet)

- (c.) Freeboard. The top of berm elevation shall be a minimum of 0.5 foot above the design flow depth over the spillway. In no case shall the spillway depth (distance between spillway crest and top of berm) be less than 1 foot.
  - (d.) Overflow spillways shall be protected with concrete, riprap or a permanent erosion control blanket (preferred) to prevent erosion of the structure. Protection shall extend across the entire spillway up to the top of berm, start on the basin side a minimum of 3 feet below the spillway crest and extend down the spillway to an apron a minimum of 6 feet beyond the toe of the spillway.
- e. Access
- (1) Berm top width shall be a minimum of 4 feet, or 12 feet where vehicle access is required for maintenance.
  - (2) A minimum 10-foot wide maintenance access route from a public or private right-of-way shall be provided to the basin. The access way (including side slopes on trapezoidal and triangular spillways) shall have a vertical grade of no greater than 16.7% (6:1 H:V slope) and shall be stabilized to withstand the passage of heavy equipment. Direct access to the forebay, control structures and the outlet shall be provided.
- f. Finishing and Top Dressing
- (1) Care must be taken during the excavation and finishing process to make sure that soil compaction does not occur.
  - (2) The bottom of dry retention basins shall be scarified or deep tilled to a depth of 6 to 12 inches after final grading has been established.
  - (3) Top Dressing for basin bottom and side slopes
    - (a.) Native permeable soil (sand and gravel); or where turf establishment is desired
    - (b.) 3-inches of compost tilled into the top 6-inches of native permeable soil (equivalent to a 9-inch homogenous mixture of 70% sand; 30% compost); or
    - (c.) 4-inches of topsoil tilled into the top 6-inches of native permeable soil (equivalent to a 10-inch homogenous mixture with maximum 20% silts, 4% clay, and 80% to 92% sand).
    - (d.) The soil mix shall have a pH between 5.5 and 7.5.
  - (4) Topsoil shall be sandy loam, loamy sand or loam per USDA Soil Textural Triangle with 20% to 50% fines by volume (silt and clay with <10% clay), and 2% to 8% organic matter by dry weight.
- g. Supplemental Measures
- (1) Supplemental measures may be required to ensure that a retention basin drains sufficiently as the soil becomes less permeable with use. The need for supplemental measures may be based on a number of indicators including:
    - (a.) Soils with a design infiltration rate between 0.50 and 1.63 inches per hour (Sandy Loam).
    - (b.) High probability for sedimentation (particularly fines).
    - (c.) Larger regional basin where there is less control over contributing area runoff.
    - (d.) Probability of groundwater rising higher than minimum isolation distance.
  - (2) Supplemental measures may include:
    - (a.) Leaching basins or infiltration trench placed in the bottom of the basin.
    - (b.) Valved outlet to drain basin.
    - (c.) Conversion to a wet basin with sufficient storage volume provided above the permanent pool for reduced infiltration area.

4. Design Schematics

**DRY RETENTION BASIN**

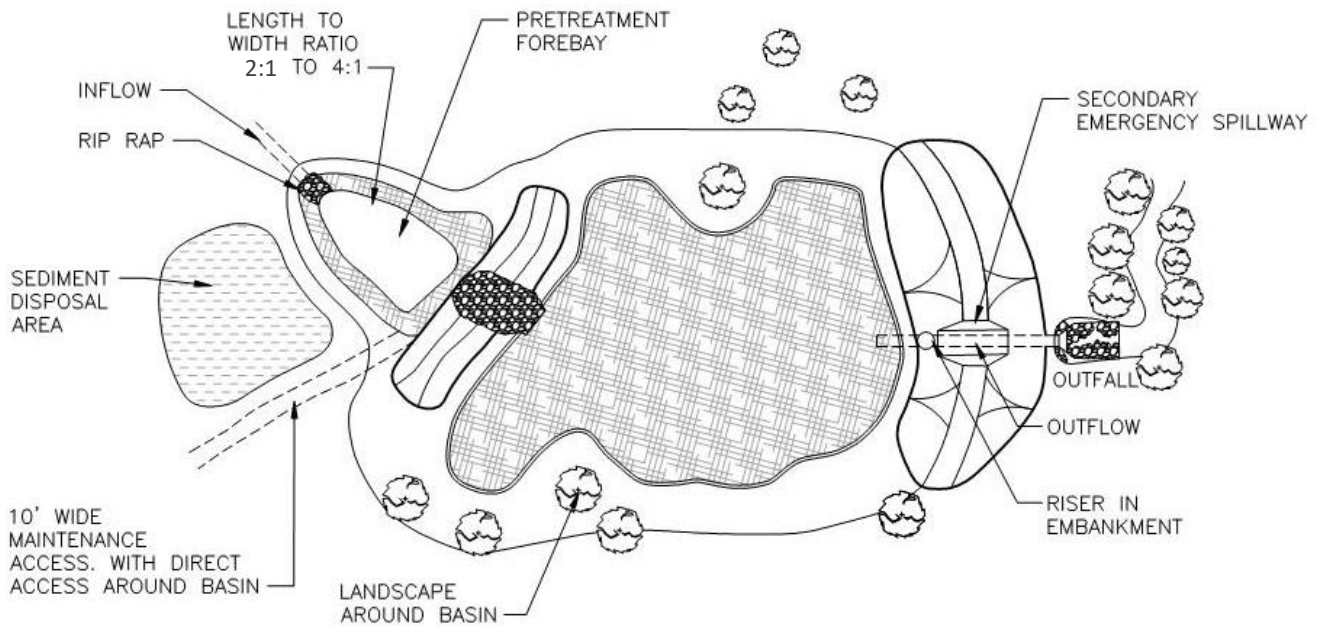

**PLAN VIEW**

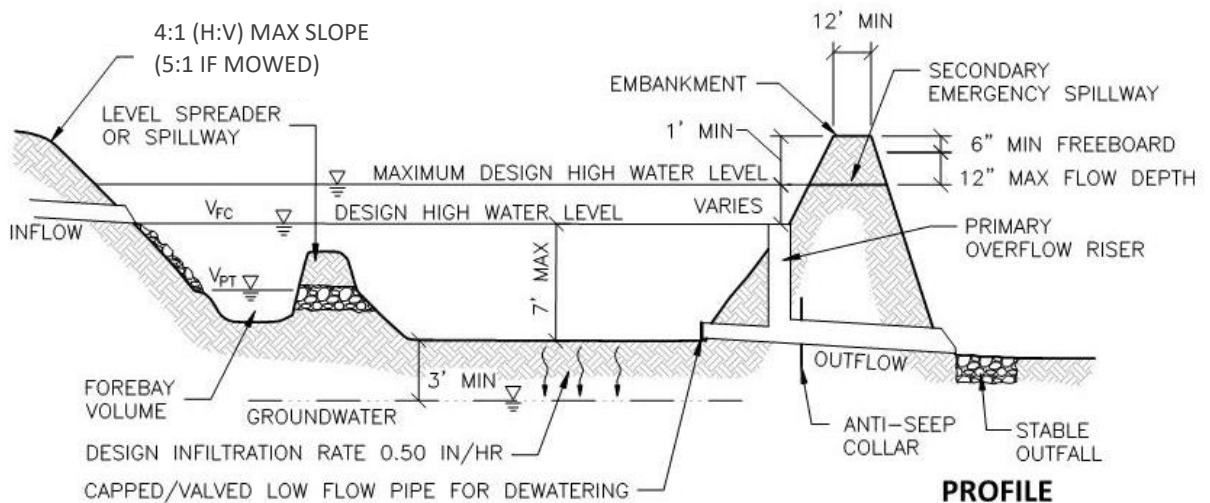

**PROFILE**

FINAL OUTLET CONFIGURATION MUST BE DESIGNED TO PREVENT CLOGGING

# WET RETENTION BASIN

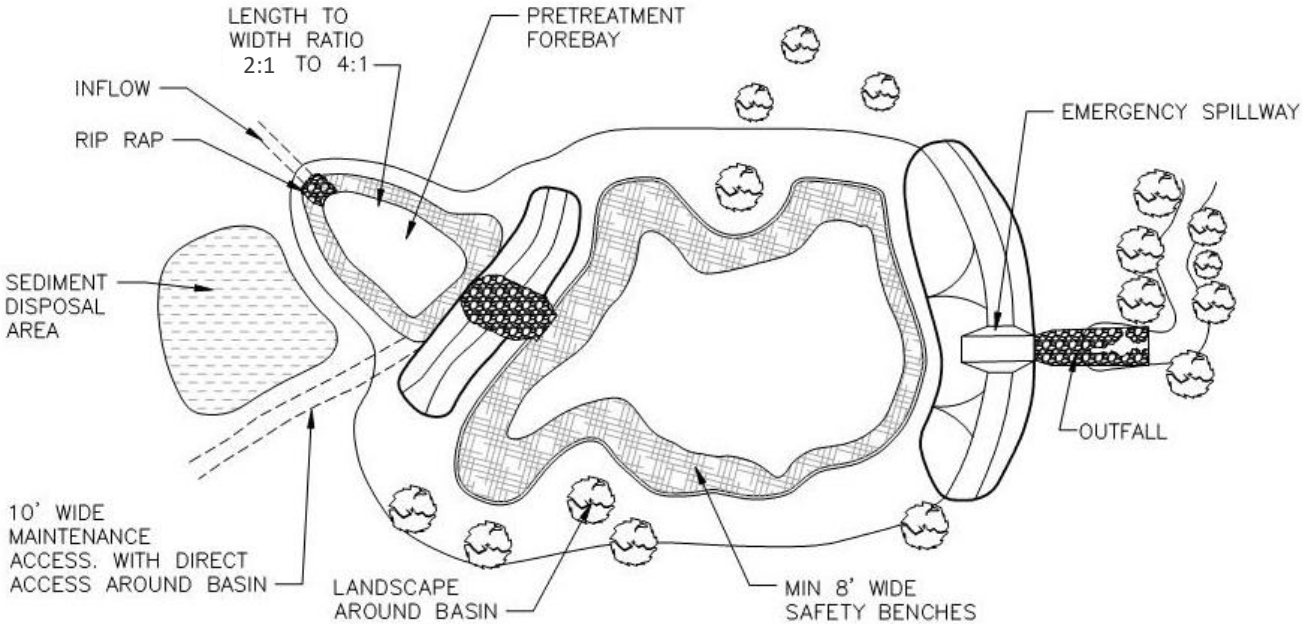

**PLAN VIEW**

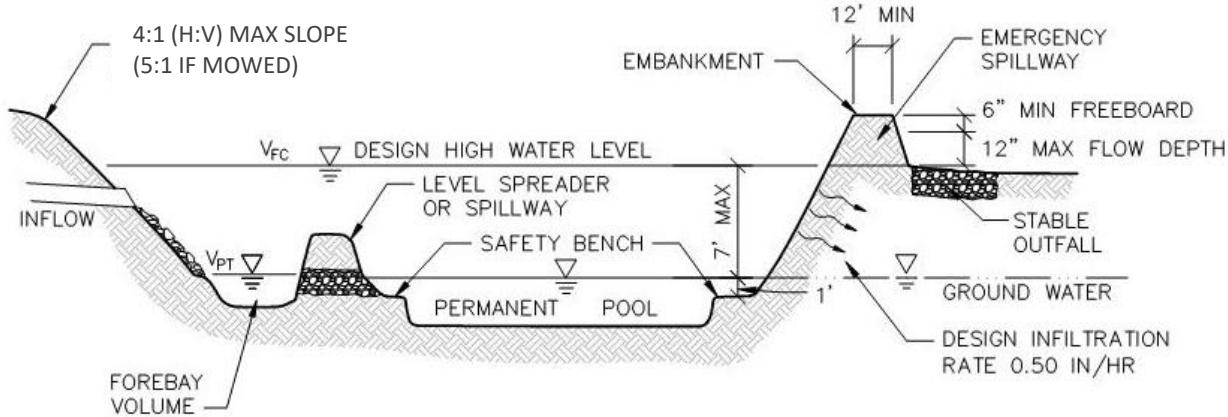

**PROFILE**

## F. Sediment Forebay

### 1. Summary

Description:	Stormwater pretreatment practice.
Application:	Typically used with a detention or retention basin.
Types:	Wet basin; Dry basin; Level spreader.
Pretreatment Required:	No. This BMP can provide pretreatment.
Maintenance Plan:	Yes.
Calculation Credits:	
Volume Reduction:	None.
Rate Reduction:	None.
Water Quality:	Count volume routed through BMP.

### 2. Sizing Calculations

- a. Size for pretreatment (refer to Part 4 section “Calculating Storage Volumes and Release Rates, Pretreatment”).
- b. The pretreatment volume is the volume of the forebay to the elevation of the level spreader or overflow spillway including any permanent pool.

### 3. Design Requirements

- a. Siting
  - (1) Where more than one inlet pipe is required, the calculated forebay volume shall be pro-rated by flow contribution of each inlet.
- b. Configuration
  - (1) The sediment forebay shall be a separate sump, which can be formed by grading.
  - (2) The minimum surface area shall be 25% of the pretreatment volume.
  - (3) The length-to-width ratio shall be a minimum of 1.5:1 and a maximum of 4:1 to allow for adequate hydraulic length yet minimize scour velocities.
  - (4) The top-of-berm elevation between the forebay and the basin shall be a minimum of 1 foot below the outer berm elevation.
  - (5) The overflow spillway shall be sized using Equations 4.25 through 4.27 and designed to prevent erosion.

### 4. Design Schematics

- a. See “Detention Basin” and “Retention Basin” BMPs.



## G. Spill Containment Cell

### 1. Summary

Description:	Lined stormwater pretreatment practice.
Application:	Typically used with a detention or retention basin.
Types:	Wet cell; Extended detention cell.
Pretreatment Required:	No. This BMP can provide pretreatment and spill containment.
Maintenance Plan:	Yes.
Calculation Credits:	
Volume Reduction:	None.
Rate Reduction:	None.
Water Quality:	Count volume routed through BMP.

### 2. Sizing Calculations

- a. Size for pretreatment (refer to Part 4 section “Calculating Storage Volumes and Release Rates, Pretreatment”).
- b. The pretreatment volume is the volume of the spill containment cell to the elevation of the level spreader or overflow spillway including any permanent pool.
- c. The spill containment volume is the storage volume between the normal water level and the entrance of the outlet pipe. The minimum spill containment volume shall be provided to capture a slug pollutant load from an accidental spill of toxic materials.

### 3. Design Requirements

- a. Siting
  - (1) All inlets shall enter the spill containment cell unless the inlet collects stormwater exclusively from non-hotspot areas (i.e. office parking, courtyard, roof.)
- b. Configuration
  - (1) The minimum surface area shall be 25% of the pretreatment volume.
  - (2) The length-to-width ratio shall be a minimum of 2:1, and a maximum of 4:1 to allow for adequate hydraulic length yet minimize scour velocities.
  - (3) The top-of-berm elevation between the spill containment cell and the basin shall be a minimum of 1 foot below the outer berm elevation.
  - (4) Side slopes shall not be steeper than 4:1 (H:V). Where basins are to be maintained as a mown lawn, side slopes shall be no steeper than 5:1 (H:V) to facilitate mowing.
  - (5) Minimum depth of the permanent pool shall be 3 feet.
  - (6) Unless protected by fencing, a minimum 4-foot wide safety bench shall be constructed around the permanent pool. The safety bench shall have a maximum slope of 6:1 (H:V) and extend a minimum of 4 inches below the permanent pool level and a minimum of 4 inches above the permanent pool level.

## c. Outlet Design

- (1) The outlet structure from the spill containment cell shall be designed to draw water from the central portion of the water column within the cell to trap floatables and contain sediments. The inlet of the transfer pipe shall be located a minimum of 1 foot below the normal water level, and a minimum of 1 foot above the bottom of the spill containment cell or manhole sump.
- (2) The transfer pipe(s) between the spill containment cell and the basin shall be sized for the peak inflow from a 10-year rainfall event.
- (3) Minimum pipe diameter shall be 12 inches.

## d. Emergency Overflow

- (1) The crest of the level spreader or overflow spillway from the spill containment cell shall be set at the elevation of the calculated 10-year hydraulic head.
- (2) The overflow spillway from the spill containment cell shall be sized using Equations 4.25 through 4.27 and designed to prevent erosion.

## e. Materials

- (1) The spill containment cell shall be lined with impermeable materials extending up to the design high water elevation. A minimum 18-inch-thick clay layer, or an impermeable liner protected with a minimum 12 inches of soil cover are acceptable alternatives. Maximum allowable permeability shall be  $1 \times 10^{-7}$  centimeters per second as determined by the geotechnical consultant for clay placement, or manufacturer's certificate for liner products.

4. Design Schematics

**SPILL CONTAINMENT CELL**

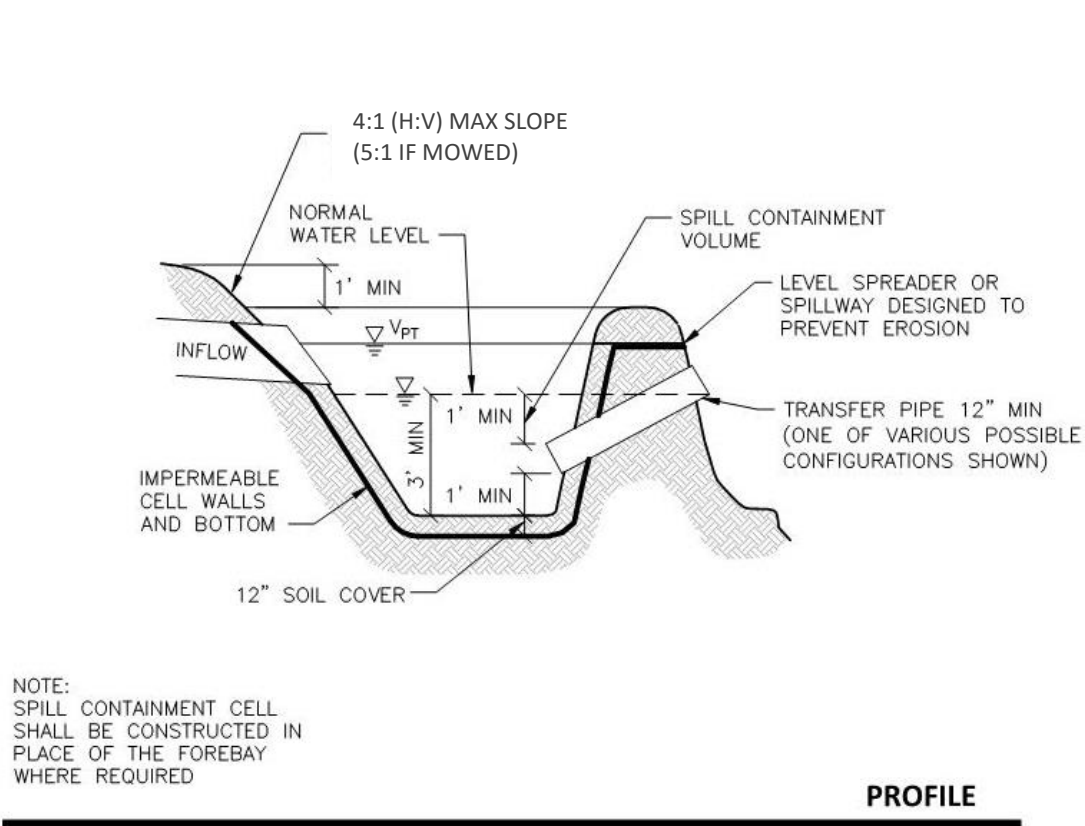
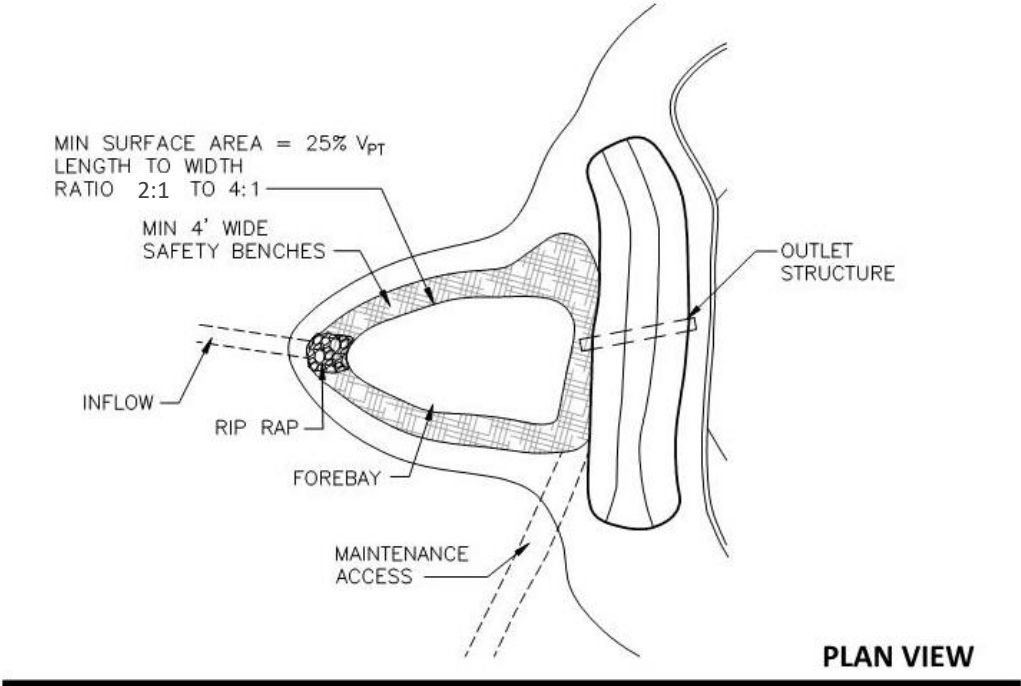

## H. Infiltration Practices

### 1. Summary

Description:	Stormwater treatment and storage without a surface outlet.
Application:	Practices are typically applicable to small sites and drainage areas.
Types:	Dry Well; Leaching Basin; Infiltration Trench; Infiltration Bed; Infiltration Berm.
Pretreatment Required:	Yes.
Maintenance Plan:	Yes.
Calculation Credits:	
Volume Reduction:	Count volume stored and infiltrated.
Rate Reduction:	Designed for flood control: 100%. Designed for channel protection and/or water quality: Adjust time-of-concentration by dividing storage volume by 10-year peak flow rate.
Water Quality:	Count volume stored and infiltrated.

### 2. Sizing Calculations

- Infiltration practices may be sized for channel protection or water quality treatment. Use the methods outlined in Part 4 section “Calculating Storage Volumes and Release Rates” to calculate the required volumes. Use the methods under “Retention” to calculate the required storage volume of the BMP.
- Infiltration practices may be able to provide flood control for small drainage areas. Use the formulas included in Part 4 section “Calculating Storage Volumes and Release Rates, Flood Control, Retention” to calculate the storage volume of the BMP.
- Calculate the minimum infiltration area required to drain the required storage volume in the specified drawdown time using the design infiltration rate (refer to Part 4 section “Design Infiltration Rates”).

$$A = \frac{12V_s}{i(t_d)} \quad (4.28)$$

where:

$A$  = minimum infiltration area (square feet)

$V_s$  = storage volume (cubic feet)

$i$  = design infiltration rate (inches per hour)

$t_d$  = maximum allowable drawdown time (hours)

12 = factor to convert inches to feet

- Total drawdown time shall be no more than 72 hours. Depth of surface ponding shall be no more than 2 feet and drain within 24 hours.

- e. Infiltration area shall be defined as:
- (1) Dry Well/Leaching Basin: Bottom of stone and ½ the height of the sides.
  - (2) Infiltration Trench: Bottom of trench (length x width) and ½ the height of each side
  - (3) Infiltration Bed: Bottom area of the bed and ½ the height of each side
  - (4) Infiltration Berm: Ponding area (length of berm x average width of ponding behind berm)
- f. Calculate the storage volume of the BMP:
- (1) Dry wells, infiltration trenches, infiltration beds:  

$$\text{Subsurface Storage Volume (cubic feet)} = \text{Length (feet)} \times \text{Width (feet)} \times \text{Depth (feet)} \times \text{Void Ratio of Material}$$

Where perforated pipe is used, the formula is modified:

$$\text{Subsurface Storage Volume (cubic feet)} = \text{Volume of Pipe (cubic feet)} + [\text{Length (feet)} \times \text{Width (feet)} \times \text{Depth (feet)} - \text{Volume of Pipe (cubic feet)}] \times \text{Void Ratio of Material}$$
  - (2) Leaching basins:  

$$\text{Storage Volume (cubic feet)} = \Pi r^2 \text{ (square feet)} \times \text{Depth (feet)}$$

where:  
r = radius of leaching basin (feet)  
 $\Pi = \pi$  (approximately 3.14)

Volume of storage in stone envelope around leaching basin may also be counted.
  - (3) Infiltration berm:  

$$\text{Surface Storage Volume (cubic feet)} = \text{Average Ponding Area (square feet)} \times \text{Design High Water Depth (feet)}$$

### 3. Design Requirements

- a. Siting
- (1) Soil borings are required (refer to Part 4 section “Soils Investigation”).
    - (a.) A minimum of 3 feet is required between the bottom of infiltration practices and the highest known groundwater elevation.
    - (b.) Void ratio for the imported material shall be based on the USDA soil textural class and effective water capacity in **Table 6**. A maximum design value of 0.40 shall be used for the void ratio of stone.
  - (2) Setbacks shall be as follows:
    - (a.) Adjacent property line: 10 feet
    - (b.) Building foundation: 10 feet
    - (c.) Private well: 50 feet
    - (d.) Public well: 200 feet from Type I or Type IIa wells, 75 feet from Type IIb or Type III wells (Safe Drinking Water Act, Act 399, PA 1976)
    - (e.) Septic system drainfield: 50 feet
  - (3) Infiltration practices shall be located outside of the drip line of adjacent trees to avoid root intrusion.

- b. Configuration
  - (1) General
    - (a.) A combination of surface and subsurface storage may be used to provide the required storage volume.
  - (2) Dry wells, infiltration trenches and infiltration beds
    - (a.) Infiltration trench width shall generally be as follows: 3-foot minimum to 6-foot maximum.
    - (b.) Coarse aggregates shall be uniformly graded, washed and wrapped in a non-woven geotextile to provide separation between the aggregate and the surrounding soil and prevent fines from clogging the infiltration surface.
    - (c.) An observation well shall be provided for each dry well, at each end of an infiltration trench, and at each corner of an infiltration bed with intermediate center wells added so as not to exceed maximum distance of 50 feet between wells.
    - (d.) Perforated pipes laid flat may be used to distribute runoff over the bottom of infiltration trenches and infiltration beds.
    - (e.) Cleanouts shall be provided at pipe ends.
    - (f.) Care must be taken during the excavation and finishing process to make sure that soil compaction does not occur.
  - (3) Leaching Basins
    - (a.) Leaching basins shall have a minimum diameter of 4 feet, and meet the layout requirements for catchbasins (refer to “Storm Sewer”).
    - (b.) Leaching basins shall have an open bottom and perforations around the circumference of the structure at no greater than 12-inch intervals horizontally and vertically the entire depth of the sump.
    - (c.) Bedding and backfill shall consist of clean stone with nonwoven geotextile fabric placed along the walls of the trench and wrapped around the stone and the basin.
  - (4) Infiltration Berms
    - (a.) Infiltration berms shall be constructed along (parallel to) contours at a constant level elevation.
    - (b.) Maximum berm height shall be 2 feet to prevent excessive ponding behind berm.
    - (c.) Berm top width shall be a minimum of 2 feet.
    - (d.) Side slopes shall not be steeper than 4:1 (H:V) to facilitate mowing and ensure stable side slopes.
    - (e.) Well compacted cohesive soil shall be used to construct the berm.
    - (f.) The berm shall be well vegetated to prevent erosion if overtopped.
- c. Inlet Design
  - (1) Pretreatment is required for each inlet and for overland flow entering the infiltration practice. Exceptions may be allowed for small paved drainage areas contributing directly to a leaching basin.
- d. Emergency Overflow
  - (1) All infiltration practices must have a provision for overflow at the high water level.
  - (2) Infiltration practices without an acceptable surface water overflow route shall be designed for 2 times the required flood control volume.
- e. Access
  - (1) Inspection and maintenance access to the infiltration practice shall be provided.

4. Design Schematics

## INFILTRATION PRACTICES

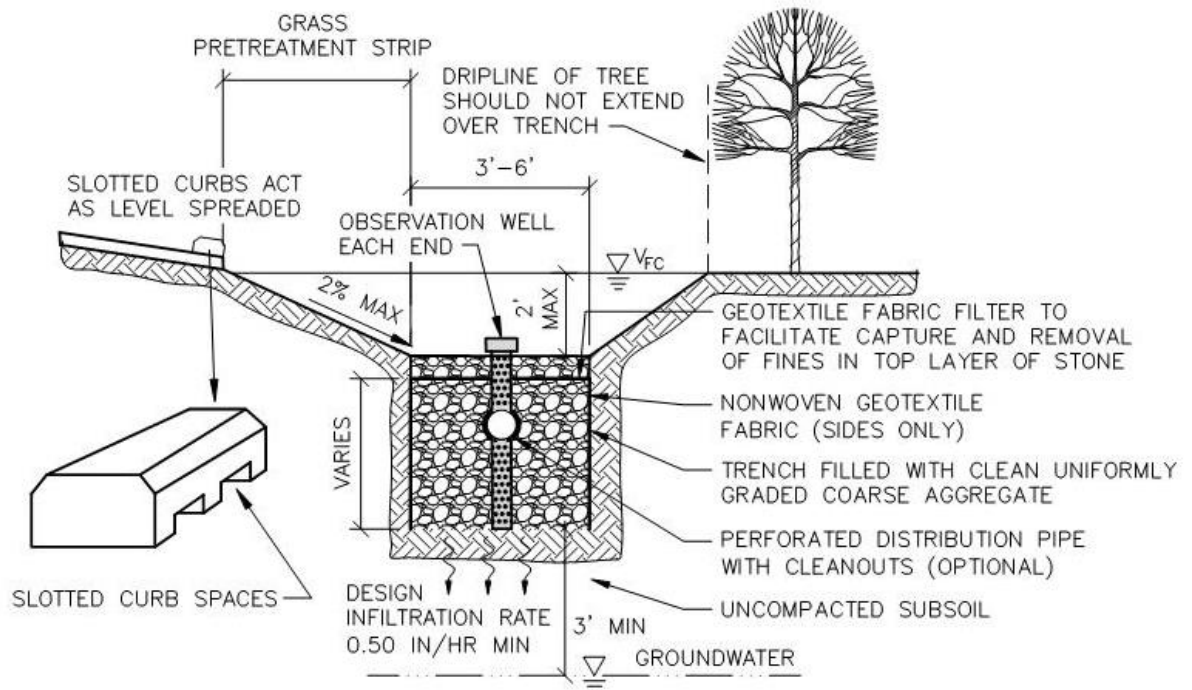

**INFILTRATION TRENCH**

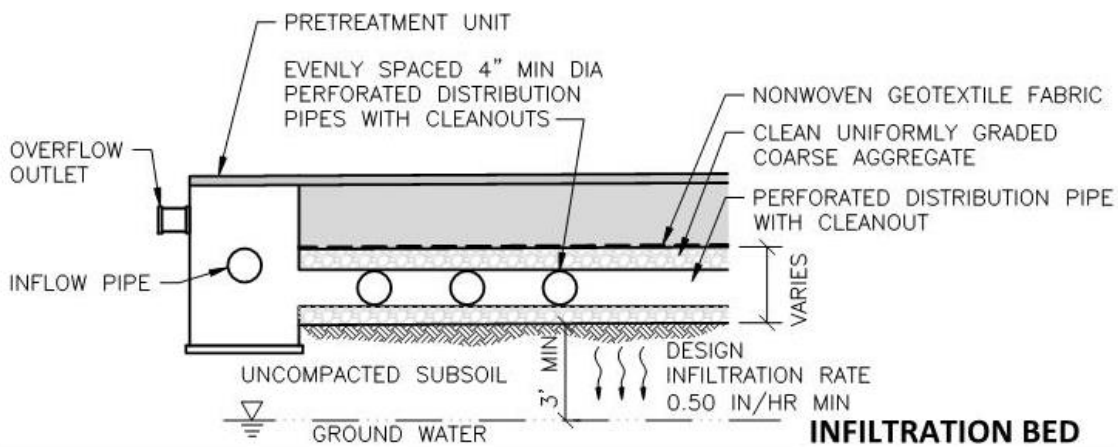

**INFILTRATION BED**

# INFILTRATION PRACTICES

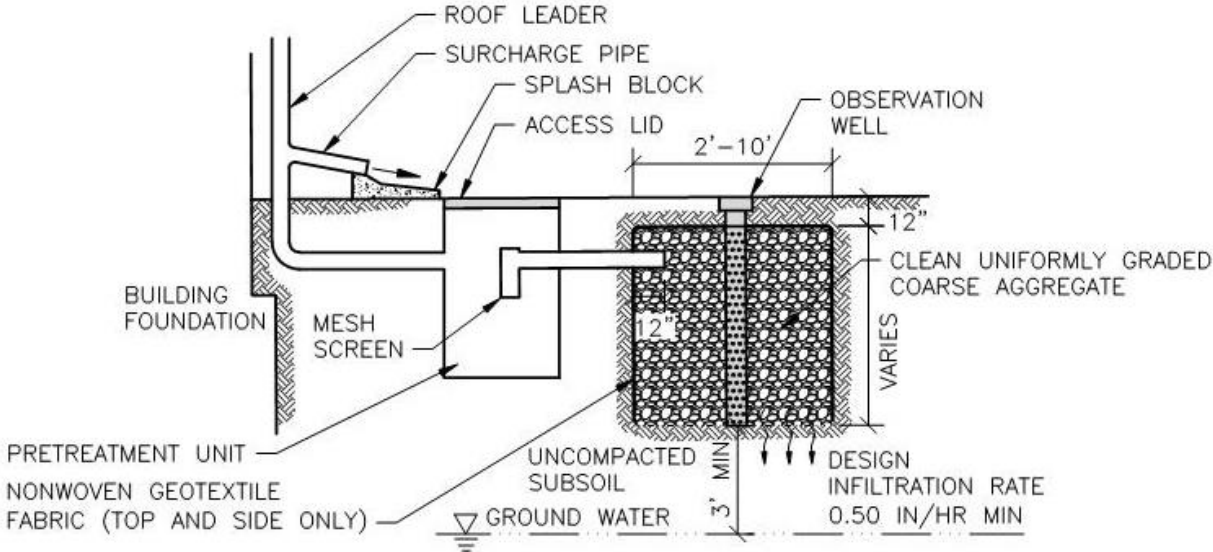

**DRY WELL**

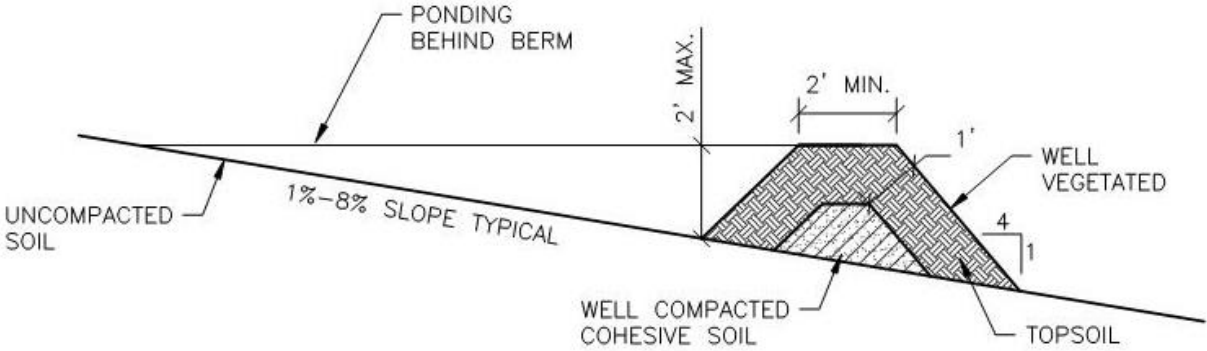

**INFILTRATION BERM**



## I. Bioretention/Rain Garden

### 1. Summary

Description:	Provides stormwater treatment, storage and uptake with or without a surface outlet.
Application:	Small sites and drainage areas. Underdrained BMP may be used on small sites to provide extended detention.
Types:	Bioretention: Natural-looking herbaceous. Rain garden: Landscaped and manicured. Infiltration; Underdrain at top of storage layer; Underdrain at bottom of storage layer; Lined.
Pretreatment Required:	Yes.
Maintenance Plan:	Yes.
Calculation Credits:	
Volume Reduction:	Infiltration: Count volume stored and infiltrated. Underdrained: Count volume stored and infiltrated between bottom of BMP and invert of underdrain.
Rate Reduction:	Adjust time-of-concentration by dividing storage volume by 10-year peak flow rate.
Water Quality:	Count volume stored and infiltrated, or routed through filter.

### 2. Sizing Calculations

- a. For underdrained BMP, follow criteria for “Constructed Filter.”
- b. Bioretention/rain gardens may be sized for channel protection or water quality treatment. Use the methods outlined in Part 4 section “Calculating Storage Volumes and Release Rates” to calculate the required volumes. Use the methods under “Retention” to calculate the required storage volume of the BMP.
- c. Bioretention/rain gardens may be able to provide flood control for small drainage areas. Use the formulas included in Part 4 section “Calculating Storage Volumes and Release Rates, Flood Control, Retention” to calculate the storage volume of the BMP.
- d. Minimum surface area (loading ratio): 0.06 times contributing impervious area, with a maximum impervious area of 1 acre (43,560 square feet) per bioretention cell.
- e. Calculate the minimum infiltration area required to drain the required storage volume in the specified drawdown time using the design infiltration rate (refer to Part 4 section “Design Infiltration Rates”). The bottom area of the BMP shall be used as the infiltration area.

$$A = \frac{12V_s}{i(t_d)} \quad (4.28)$$

where:

- A = minimum infiltration area (square feet)
- V<sub>s</sub> = storage volume (cubic feet)
- i = design infiltration rate (inches per hour)
- t<sub>d</sub> = maximum allowable drawdown time (hours)
- 12 = factor to convert inches to feet

- f. Total drawdown time shall be no more than 72 hours. Depth of surface ponding shall be no more than 12 inches and drain within 12 hours. Surface ponding depth may be increased up to 24 inches for bioretention areas and drain within 24 hours.

- g. Calculate the storage volume of the BMP:

*Average Bed Area (square feet) = [Area at Design High Water Depth (square feet) + Bottom Area (square feet)] / 2*

*Surface Storage Volume (cubic feet) = Average Bed Area (square feet) x Design High Water Depth (feet)*

*Subsurface Storage Volume (cubic feet) = Length (feet) x Width (feet) x Depth (feet) x Void Ratio of Material*

*Note: Count subsurface storage volume only if permeability of media is greater than permeability of subsoil.*

*Total Storage Volume (cubic feet) = Surface Storage Volume (cubic feet) + Subsurface Storage Volume (cubic feet)*

### 3. Design Requirements

- a. Siting

- (1) Soil borings are required (refer to Part 4 section "Soils Investigation").
  - (a.) A minimum of 3 feet is required between the bottom of bioretention/rain gardens capable of infiltration and the highest known groundwater elevation.
  - (b.) A minimum of 2 feet is required between the bottom of lined or underdrained bioretention/rain gardens and the highest known groundwater elevation.
  - (c.) An underdrain shall be provided for design infiltration rates of the underlying native soil less than 0.50 inches per hour, or if bioretention/rain garden will be lined.
  - (d.) Void ratio for the amended soil material shall be based on the USDA soil textural class and effective water capacity in **Table 6**. A maximum design value of 0.30 shall be used for the void ratio of the amended soil material. A maximum design value of 0.40 shall be used for the void ratio of stone.
- (2) Setbacks shall be as follows:
  - (a.) Adjacent property line: 10 feet
  - (b.) Building foundation: 10 feet
  - (c.) Private well: 50 feet
  - (d.) Public well: 200 feet from Type I or Type IIa wells, 75 feet from Type IIb or Type III wells (Safe Drinking Water Act, Act 399, PA 1976)
  - (e.) Septic system drainfield: 50 feet

- b. Configuration

- (1) General
  - (a.) The bottom shall be flat to encourage uniform ponding and infiltration.
  - (b.) Minimum bottom width shall be 3 feet.
  - (c.) Bioretention/rain gardens located in areas with steep slopes shall be terraced to minimize earth disturbance and maximize infiltration area.
  - (d.) Care must be taken during the excavation and finishing process to make sure that soil compaction does not occur.

- (e.) Bioretention/rain gardens located in areas of existing soil contamination shall be lined to prevent infiltration.
  - (f.) Underdrains shall have a 4-inch minimum pipe diameter.
  - (g.) All underground pipes shall have clean-outs accessible from the surface.
  - (h.) Pipes shall be sloped to prevent siltation.
  - (i.) Side slopes shall not be steeper than 3:1 (H:V), unless landscape retaining walls are used.
  - (j.) An observation well shall be provided for each bioretention/rain garden without a bottom underdrain.
- (2) Rain gardens
- (a.) A landscape plan shall be provided.
- c. Inlet Design
- (1) Inlet pipes shall require energy dissipation. Riprap protection or equivalent erosion control measures shall be used where the velocity exceeds 4 feet per second up to a maximum allowable design velocity of 8 feet per second.
  - (2) Pretreatment is required for each inlet and for overland flow entering the bioretention/rain garden.
- d. Emergency Overflow
- (1) All bioretention/rain gardens must have a provision for overflow at the high water level.
- e. Materials
- (1) Amended soil material shall consist of 18 to 48 inches of the following materials, evenly mixed: Compost: minimum 20%; Sand: 20-80% ; Topsoil: maximum 30%.
    - (a.) Alternative mix designs with ratios outside of the limits provided will be considered with justification.
    - (b.) The soil mix shall have a pH between 5.5 and 7.5.
  - (2) Topsoil shall be sandy loam, loamy sand or loam per USDA Soil Textural Triangle with 20% to 50% fines by volume (silt and clay with <10% clay), and 2% to 8% organic matter by dry weight.
  - (3) Stone shall consist of clean, uniformly graded coarse aggregate.
  - (4) A woven geotextile fabric shall be placed between the amended soil and the stone, when a stone layer is used.
  - (5) When used, impermeable liner shall have a maximum permeability of  $1 \times 10^{-7}$  centimeters per second certified by the manufacturer.
  - (6) Plant selection shall consider exposure and tolerance to salt, sediment and pollutants, and the design depth of surface storage. Native species are encouraged.
    - (a.) Bioretention: Plugs and seed.
    - (b.) Rain gardens: Container stock.
  - (7) Mulch shall be applied after planting.
    - (a.) Bioretention: Shredded hardwood mulch, straw mulch or mulch blanket shall be uniformly applied and tacked.
    - (b.) Rain gardens: Shredded hardwood mulch shall be uniformly applied to a depth of 2 to 3 inches.
- f. Access
- (1) Inspection and maintenance access to the bioretention/rain garden shall be provided.

4. Design Schematics

**BIORETENTION/RAIN GARDEN**

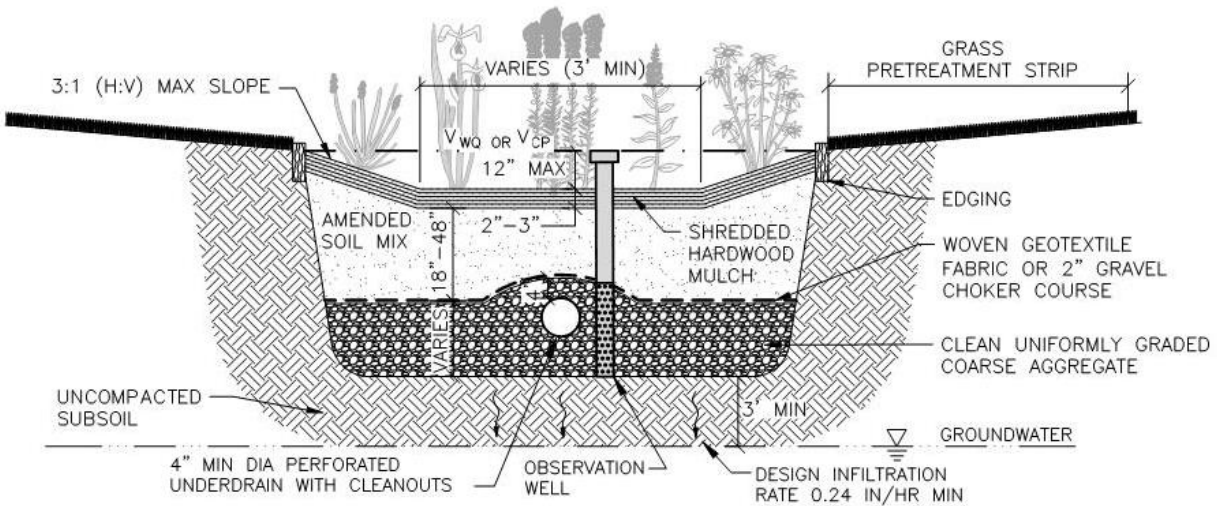
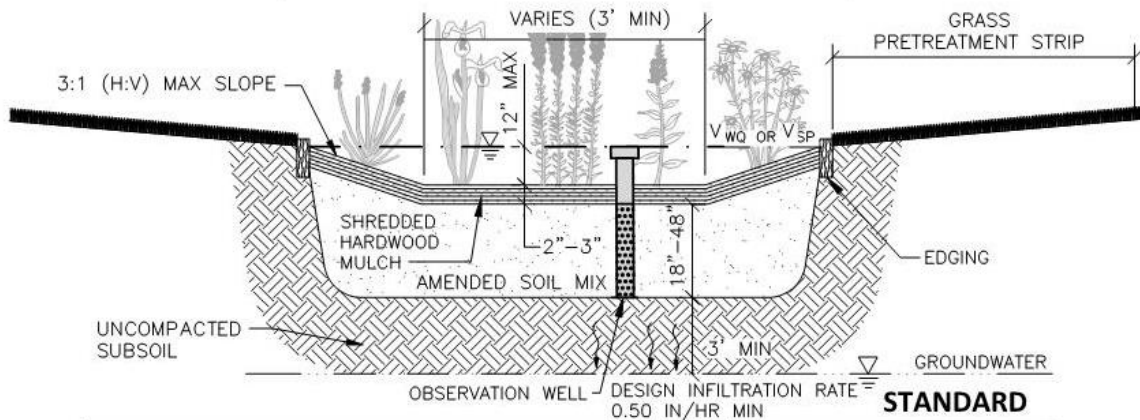

**BIORETENTION/RAIN GARDEN WITH STONE STORAGE LAYER**

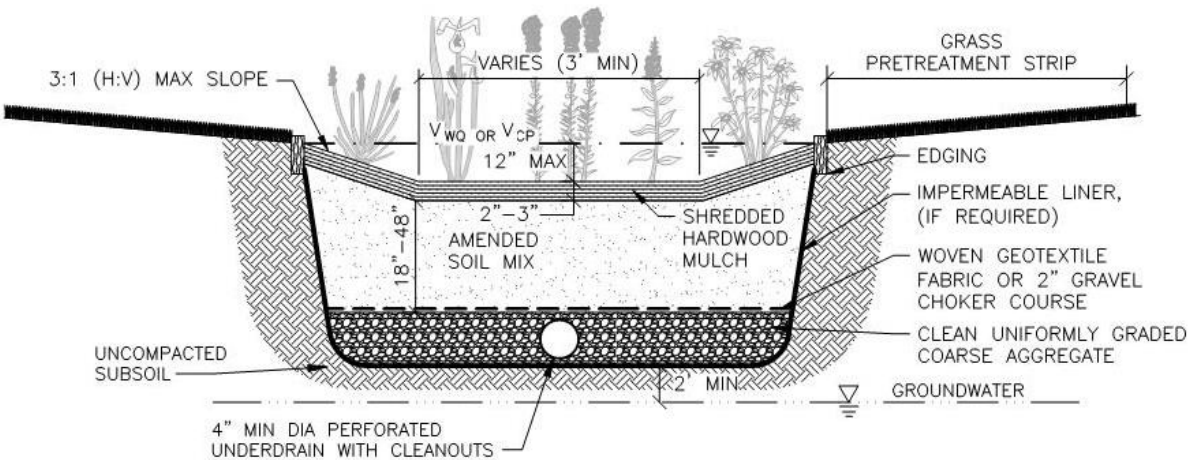

**BIORETENTION/RAIN GARDEN WITH BOTTOM DRAIN**

## J. Constructed Filter

### 1. Summary

Description:	Provides stormwater treatment and storage with a surface outlet (underdrain).
Application:	Areas with high heavy metal pollutant loads. May be used on small sites to provide extended detention.
Types:	Sand; Gravel; Sand/compost mix; Other media. Dry; Static water level within filter media.
Pretreatment Required:	Yes.
Maintenance Plan:	Yes.
Calculation Credits:	
Volume Reduction:	None.
Rate Reduction:	Adjust time-of-concentration by dividing storage volume by 10-year peak flow rate.
Water Quality:	Count volume routed through filter.

### 2. Sizing Calculations

- Use the methods outlined in Part 4 section “Calculating Storage Volumes and Release Rates” to calculate the required volumes for channel protection, water quality and/or pretreatment. Use the methods under “Retention” to calculate the required storage volume of the BMP.
- Calculate filter surface area required to drain the design volume in the specified drawdown time using hydraulic conductivity of filter media:

$$A = \frac{V(d_f)}{K(t_d)(h_f + d_f)} \quad (4.29)$$

where:

- A = minimum surface area of filter (square feet)
- V = design runoff volume (cubic feet)
- $d_f$  = depth of filter media (1.5-foot minimum to 3-foot maximum)
- K = hydraulic conductivity (feet per day)
- $t_d$  = maximum allowable drawdown time (days)
- $h_f$  = average head; typically ½ of the maximum head on filter media (feet)

- Total drawdown time shall be no more than 72 hours. Maximum depth of surface ponding above the filter bed shall be 24 inches and drain within 24 hours.
- Check whether soil conductivity or hydraulics of underdrain governs.

### 3. Design Requirements

- Siting
  - Soil borings are required (refer to Part 4 section “Soils Investigation”).
    - A minimum of 2 foot is required between the bottom of the constructed filter and the highest known groundwater elevation.
    - Design values for hydraulic conductivity of the filter media shall be as specified in **Table 14**. Values for other types of filter media will be reviewed for use on an individual basis.

**Table 14 –Hydraulic Conductivities for Filter Media**

Filter Media	Hydraulic Conductivity, K (feet per day)
Gravel	14 <sup>1</sup>
Compost (loose)	8.7 <sup>2</sup>
Coarse Sand	3.5 <sup>2</sup>
Peat	2 <sup>2</sup>
Topsoil (< 10% clay)	1.3 <sup>3</sup>
<p><sup>1</sup> Adapted from William E. Sanford, et. al. (1995). <i>Hydraulic Conductivity of Gravel and Sand as Substrates in Rock-reed Filters</i>, Table 3 (using lowest initial conductivity for sand and gravel (0.25 cm/s) and correction factors from Source 2 (p. 5-18) to obtain a design value).</p> <p><sup>2</sup> Center for Watershed Protection (1996). <i>Design of Stormwater Filtering Systems</i>.</p> <p><sup>3</sup> D. Carpenter and L. Hallam (2007). <i>An Investigation of Rain Garden Planting Mixtures and the Implications for Design</i>.</p> <p>A composite value of hydraulic conductivity for mixture combinations shall be calculated as: <math>K = (\% \times K1 + \% \times K2 + \% \times K3) / 100</math></p> <p>Effective infiltration rate, <math>i</math> (in/hr) = <math>\frac{K(h_f + d_f)}{2d_f}</math> for filter; <math>i = K/2</math> for top dressing in retentive BMPs. Variables are as defined in Equation 4.29.</p>	

b. Configuration

- (1) Filter media shall have a minimum depth of 18-inches and a maximum depth of 36 inches.
- (2) Stone bedding shall consist of at least 2 inches under the pipe and 4 inches above the pipe. An aggregate window extending to the filter surface may also be provided as a factor-of-safety.
- (3) A 4-inch minimum diameter underdrain shall be provided in the gravel layer with lateral spacing at 10 feet, and in any case no more than 25 feet.
- (4) All underground pipes shall have clean-outs accessible from the surface.
- (5) Pipes shall be sloped to prevent siltation.
- (6) Constructed filters located in areas of existing soil contamination shall be lined to prevent infiltration.

c. Inlet Design

- (1) A level spreader, distribution pipes or other flow dispersion measure shall be used for energy dissipation and to uniformly distribute the flow.
- (2) Pretreatment is required for each inlet and for overland flow entering the constructed filter.

## d. Emergency Overflow

- (1) All constructed filters must be designed so that larger storms may safely overflow or bypass the filter. Flow splitters, multi-stage chambers or other devices may be used.
- (2) Sufficient space must be provided between the top of the filtering bed and the overflow to allow the maximum design head to be stored for filtration.

## e. Materials

- (1) Stone bedding shall consist of clean, uniformly graded coarse aggregate (MDOT coarse or open-graded aggregate).
- (2) A woven geotextile fabric, or an additional 2 inches of gravel choker course shall be placed between the filter media layer(s) and the stone layer.
- (3) When used, impermeable liner shall have a maximum permeability of  $1 \times 10^{-7}$  centimeters per second certified by the manufacturer.

## f. Access

- (1) Inspection and maintenance access to the constructed filter shall be provided.
- (2) For underground vault heights greater than 4 feet, ladder access shall be provided.

## 4. Design Schematics

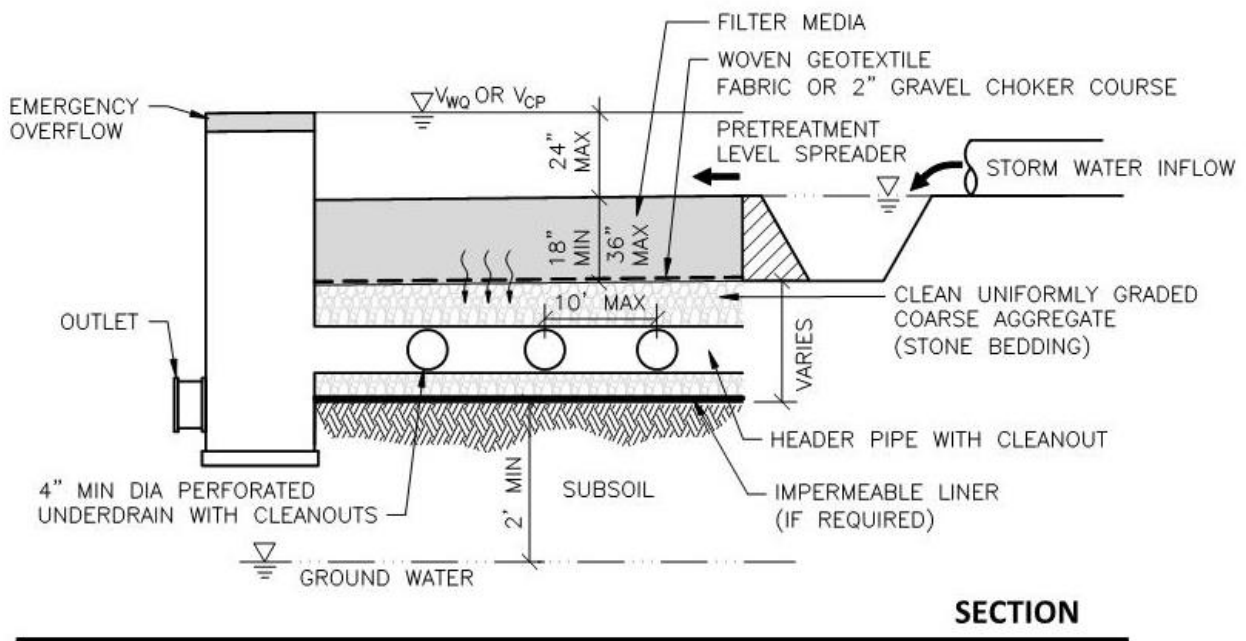
**CONSTRUCTED FILTER**

## K. Planter Box

### 1. Summary

Description:	A type of rain garden.
Application:	Small sites or highly urban areas. Underdrained BMP may be used on small sites to provide extended detention.
Types:	Infiltration; Underdrain at top of storage layer; Underdrain at bottom of storage layer; Lined.
Pretreatment Required:	No.
Maintenance Plan:	Yes.
Calculation Credits:	
Volume Reduction:	Infiltration: Count volume stored and infiltrated. Underdrained: Count volume stored and infiltrated between bottom of BMP and invert of underdrain.
Rate Reduction:	Adjust time-of-concentration by dividing storage volume by 10-year peak flow rate.
Water Quality:	Count volume stored and infiltrated, or routed through filter.

### 2. Sizing Calculations

- For underdrained BMP, follow criteria for “Constructed Filter.”
- Planter boxes may be sized for channel protection or water quality treatment. Use the methods outlined in Part 4 section “Calculating Storage Volumes and Release Rates” to calculate the required volumes. Use the methods under “Retention” to calculate the required storage volume of the BMP.
- Minimum surface area (loading ratio): 0.06 times contributing impervious area, with a maximum impervious area of 15,000 square feet per planter box.
- Calculate the minimum infiltration area required to drain the required storage volume in the specified drawdown time using the design infiltration rate (refer to Part 4 section “Design Infiltration Rates”).

$$A = \frac{12V_s}{i(t_d)} \quad (4.28)$$

where:

$A$  = minimum infiltration area (square feet)

$V_s$  = storage volume (cubic feet)

$i$  = design infiltration rate (inches per hour)

$t_d$  = maximum allowable drawdown time (hours)

12 factor to convert inches to feet

- Total drawdown time shall be no more than 12 hours. Depth of surface ponding shall be no more than 12 inches and drain within 4 hours.
- The bottom area of the BMP shall be used as the infiltration area.



- g. Calculate the storage volume of the BMP:

*Surface Storage Volume (cubic feet) = Bed Area (square feet) x Design High Water Depth (feet)*

*Subsurface Storage Volume (cubic feet) = Length (feet) x Width (feet) x Depth (feet) x Void Ratio of Material*

*Note: Count subsurface storage volume only if permeability of media is greater than permeability of subsoil.*

*Total Storage Volume (cubic feet) = Surface Storage Volume (cubic feet) + Subsurface Storage Volume (cubic feet)*

### 3. Design Requirements

- a. Siting

- (1) Soil borings are required (refer to Part 4 section “Soils Investigation”).
  - (a.) A minimum of 3 feet is required between the bottom of the planter box and the highest known groundwater elevation.
  - (b.) A minimum of 2 foot is required between the bottom of a lined or underdrained planter box and the highest known groundwater elevation.
  - (c.) An underdrain shall be provided for design infiltration rates less than 0.50 inches per hour, or if planter box will be lined.
  - (d.) Void ratio for the amended soil material shall be based on the USDA soil textural class and effective water capacity in **Table 6**. A maximum design value of 0.30 shall be used for the void ratio of the amended soil material. A maximum design value of 0.40 shall be used for the void ratio of stone.

- b. Configuration

- (1) A combination of surface and subsurface storage may be used to provide the required storage volume.
- (2) Minimum width of planter boxes shall be 30 inches, or 18 inches if flow-through.
- (3) Care must be taken during the excavation and finishing process to make sure that soil compaction does not occur.
- (4) Planter boxes located in areas of existing soil contamination shall be lined to prevent infiltration.
- (5) Underdrains shall have a 4-inch minimum pipe diameter.
- (6) All underground pipes shall have clean-outs accessible from the surface.
- (7) Pipes shall be sloped to prevent siltation.
- (8) A planting plan shall be provided.

- c. Inlet Design

- (1) Inlet pipes shall require energy dissipation. Riprap protection or equivalent erosion control measures shall be used where the velocity exceeds 4 feet per second, up to a maximum allowable design velocity of 8 feet per second.

- d. Emergency Overflow

- (1) All planter boxes must have a provision for overflow at the high water level.

## e. Materials

- (1) Suggested structural elements of planter boxes are stone, concrete, brick or pressure-treated wood.
- (2) Amended soil material shall consist of 12 to 36 inches of the following materials, evenly mixed: Compost: minimum 20%; Sand: 20-80% ; Topsoil: maximum 30%.
  - (a.) Alternative mix designs with ratios outside of the limits provided will be considered with justification.
  - (b.) The soil mix shall have a pH between 5.5 and 6.5.
- (3) Topsoil shall be sandy loam, loamy sand or loam per USDA Soil Textural Triangle with 20% to 50% fines by volume (silt and clay with <10% clay), and 2% to 8% organic matter by dry weight.
- (4) Stone bedding shall consist of clean, uniformly graded coarse aggregate.
- (5) A woven geotextile fabric shall be placed between the amended soil and the stone.
- (6) Impermeable liner shall have a maximum permeability of  $1 \times 10^{-7}$  centimeters per second certified by the manufacturer.
- (7) Plant selection shall consider exposure and tolerance to salt, sediment and pollutants, and the design depth of surface storage. Native species are encouraged.
- (8) Plants shall be container stock.

- f. Access. Inspection and maintenance access to the planter box shall be provided.

## 4. Design Schematics

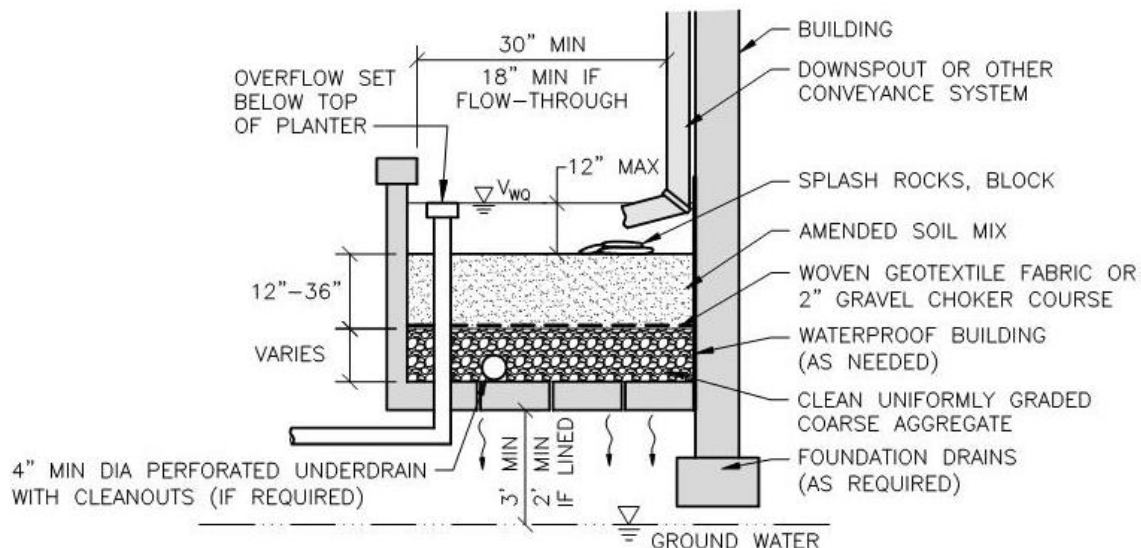
**PLANTER BOX**

PLANTER MAY HAVE AN  
OPEN BOTTOM OR BE LINED

**SECTION**

## L. Pervious Pavement

### 1. Summary

Description:	Provides stormwater treatment and storage with or without a surface outlet.
Application:	Parking lots, alleys and roads and drives with low-volume vehicular traffic and minimal turning motions.
Types:	Infiltration; Underdrain at top of storage layer; Underdrain at bottom of storage layer; Lined.
Pretreatment Required:	No.
Maintenance Plan:	Yes.
Calculation Credits:	
Volume Reduction:	Infiltration: Count volume stored and infiltrated (limited by design rainfall on pavement and roof). Underdrained: Count volume stored and volume infiltrated between bottom of BMP and invert of underdrain (limited by design rainfall on pavement and roof).
Rate Reduction:	Infiltration: 100%. Underdrained: Calculated allowable release rate.
Water Quality:	Count volume stored and infiltrated, or volume filtered.

### 2. Sizing Calculations

- a. For underdrained BMP, follow criteria for “Constructed Filter.”
- b. Use the methods outlined in Part 4 section “Calculating Storage Volumes and Release Rates” to calculate the required volumes for water quality and channel protection.
- c. Use the formulas included in Part 4 section “Calculating Storage Volumes and Release Rates, Flood Control, Retention” to calculate the storage volume of the BMP for flood control.
- d. The bottom area of the BMP shall be used as the infiltration area.
- e. Maximum allowable drawdown time shall be 72 hours.
- f. Calculate the subsurface storage volume of the BMP:

$$\text{Subsurface Storage Volume (cubic feet)} = \text{Length (feet)} \times \text{Width (feet)} \times \text{Depth (feet)} \times \text{Void Ratio of Material}$$

### 3. Design Requirements

- a. Siting
  - (1) Soil borings are required (refer to Part 4 section “Soils Investigation”).
    - (a.) A minimum of 3 feet is required between the bottom of pervious pavement capable of infiltration and the highest known groundwater elevation.
    - (b.) A minimum of 2 foot is required between the bottom of lined or underdrained pervious pavement and the highest known groundwater elevation.
    - (c.) An underdrain shall be provided for design infiltration rates less than 0.50 inches per hour, or if stone bed will be lined.
    - (d.) A maximum design value of 0.40 shall be used for the void ratio of stone.

- (2) Runoff from offsite areas shall not be directed onto pervious pavement surface.
- b. Configuration
    - (1) The stone bed shall be flat to encourage uniform ponding and infiltration.
    - (2) For pervious pavements located in areas with steep slopes, stone beds shall be terraced to maximize infiltration area.
    - (3) Pervious pavements located in areas of existing soil contamination shall be lined to prevent infiltration.
    - (4) Underdrains shall have a 4-inch minimum pipe diameter with lateral spacing at 10 feet, and in any case no more than 25 feet.
    - (5) All underground pipes shall have clean-outs accessible from the surface.
    - (6) Pipes shall be sloped to prevent siltation.
  - c. Inlet Design
    - (1) Pervious pavements shall have a backup method for water to enter the storage bed. Backup drainage may consist of an unpaved 1- to 2-foot wide stone edge or inlets with sediment traps.
  - d. Emergency Overflow
    - (1) Stone beds must have a provision for overflow below the level of the pavement surface when an underdrain is not already provided.
  - e. Materials
    - (1) Stone bed shall consist of 8 to 36 inches of clean, uniformly graded coarse aggregate.
    - (2) A woven geotextile fabric or 2-inch gravel choker course shall be placed between the pervious pavement and stone bed.
    - (3) A nonwoven geotextile fabric or liner shall be placed between the stone bed and the subsoil for underdrained pavements.
    - (4) Impermeable liner shall have a maximum permeability of  $1 \times 10^{-7}$  centimeters per second certified by the manufacturer.

4. Design Schematics

**PERVIOUS PAVEMENT**

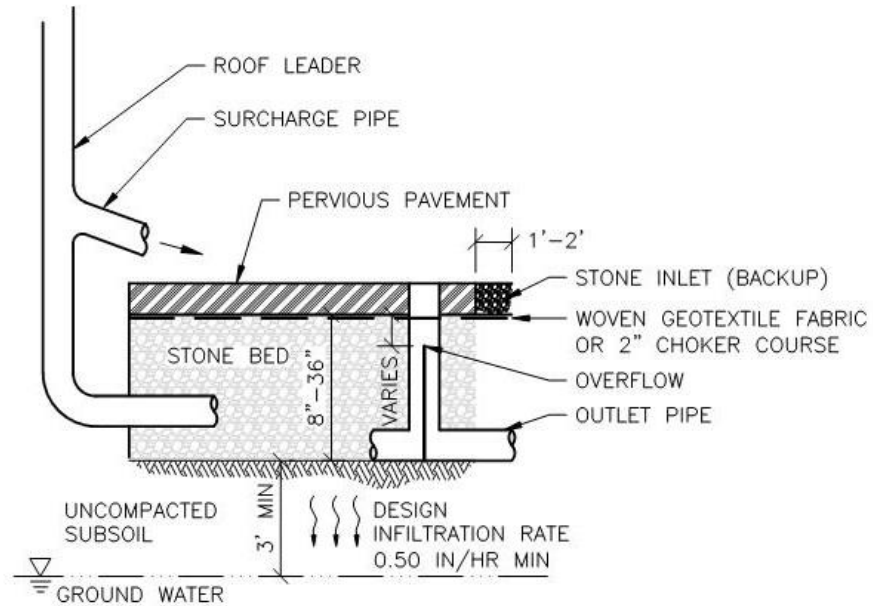

**STANDARD**

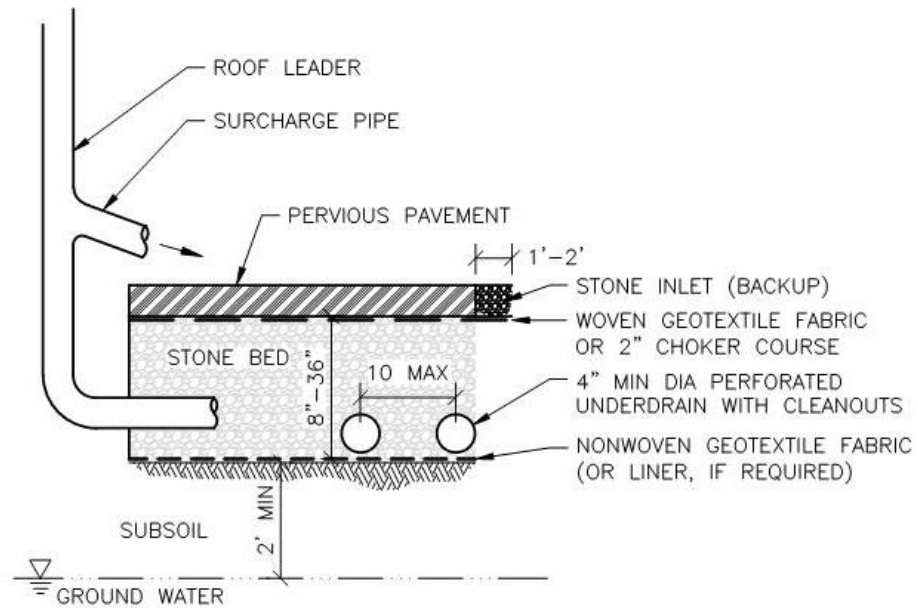

**PERVIOUS PAVEMENT WITH BOTTOM DRAIN**

## M. Capture Reuse

### 1. Summary

Description:	Stormwater capture, storage and removal from storm flow by reuse for irrigation or as greywater.
Application:	Most practical for roof runoff. Other collection areas may require pumping for reuse.
Types:	Rain barrels; Cisterns (both above ground and underground); Tanks; Ponds.
Pretreatment Required:	Yes. This BMP can provide spill containment.
Maintenance Plan:	Yes.
Calculation Credits:	
Volume Reduction:	Count storage volume provided.
Rate Reduction:	Adjust time-of-concentration by dividing storage volume by 10-year peak inflow rate.
Water Quality:	Count volume stored.

### 2. Sizing Calculations

- Determine water use (gallons per day) and add up for each month of the year.
- Obtain average monthly precipitation (inches) and evapotranspiration (ET) in inches.  
[www.enviroweather.msu.edu](http://www.enviroweather.msu.edu)
- Multiply average monthly precipitation by contributing area and area-weighted Small Storm Hydrology Method runoff coefficient (assuming 90% of the storms produce 1 inch of rain or less) to obtain volume of recharge. A modified equation for the Small Storm Hydrology Method is given below:

$$V = PR_v A(3630) \quad (4.30)$$

where:

$V$  = recharge volume (cubic feet)

$P$  = rainfall (inches)

$R_v$  = area-weighted volumetric runoff coefficient (individual runoff coefficients are given in **Table 10**)

$A$  = contributing area (acres)

$3630$  = factor to convert acre-inches to cubic feet

- Multiply recharge volume by 7.48 gallons per cubic foot to convert to gallons.
- Calculate ET for open water surfaces. Multiply average monthly ET (inches) by surface area of pond (square feet) and divide by 12 to calculate the volume of water evaporated in cubic feet. Multiply by 7.48 gallons per cubic foot to convert to gallons.
- Select trial size container or pond volume.
- Calculate the water balance. A tabular method may be used similar to that illustrated below.
- Adjust size of container or pond to balance reuse efficiency and cost.

*Volume of Water in Storage at End of Month = Storage Volume at Start of Month + Recharge from Monthly Precipitation – ET – Monthly Water Use*

Month	Vstart	+Recharge	-Et	-Use	=Vend*	Lost
1						
2	=Vend1					
Total	--				--	

\*Limited by total volume of the selected container or pond. If value is greater than container volume, surplus is lost to overflow. If value is negative, it means that amount must be supplemented.

### 3. Design Requirements

#### a. Siting

- (1) Storage units shall be positioned to receive rooftop runoff.
- (2) Protect storage units from direct sunlight to minimize algae growth.
- (3) Discharge points and storage units shall be clearly marked "Caution: Untreated Rainwater. Do Not Drink."

#### b. Configuration

- (1) If storage units are used to supplement greywater needs, a parallel conveyance system must be installed to separate greywater from other potable water piping systems.
- (2) Storage units shall be watertight with a smooth interior surface.
- (3) Covers and lids shall have a tight fit to keep out surface water, insects, animals, dust and light.
- (4) Observation risers shall be provided for buried storage units.
- (5) Pumps and pressure tanks may be used to add pressure (most irrigation systems require at least 15 pounds per square inch).

#### c. Inlet Design

- (1) Screens shall be used to filter debris from runoff flowing into the storage unit.

#### d. Emergency Overflow

- (1) A positive outlet for overflow shall be provided a few inches from the top of the storage unit and sized to safely discharge the peak flow from the 10-year design storm when the storage unit is full.
- (2) Above-ground storage units shall have a release mechanism to drain and empty the unit between storm events.

## N. Vegetated Roof

### 1. Summary

Description:	Provides stormwater treatment and storage with a surface overflow.
Application:	Most practical for flat rooftops.
Types:	Intensive (> 4 inches, wide variety of plants, public use); Extensive (≤ 4 inches, plants are herbs, mosses, succulents and grasses).
Pretreatment Required:	No. This BMP can provide pretreatment.
Maintenance Plan:	Yes.
Calculation Credits:	
Volume Reduction:	Count subsurface storage volume below the overflow (limited by design rainfall on roof).
Rate Reduction:	Adjust time-of-concentration by dividing storage volume by 10-year peak inflow rate.
Water Quality:	Count subsurface storage volume.

### 2. Sizing Calculations

- For water quality, the minimum subsurface storage volume shall be equal to the volume from 1-inch of rain falling on the roof area.
- For channel protection, the subsurface storage volume below the overflow may be counted as retention.
- Calculate the subsurface storage volume of the BMP:

*Subsurface Storage Volume (cubic feet) = Length (feet) x Width (feet) x Depth (feet) x Void Ratio of Material.*

### 3. Design Requirements

- Configuration: Follow manufacturer's and structural engineer's guidelines.
- Emergency Overflow: A positive outlet for overflow shall be provided.

### 4. Design Schematics

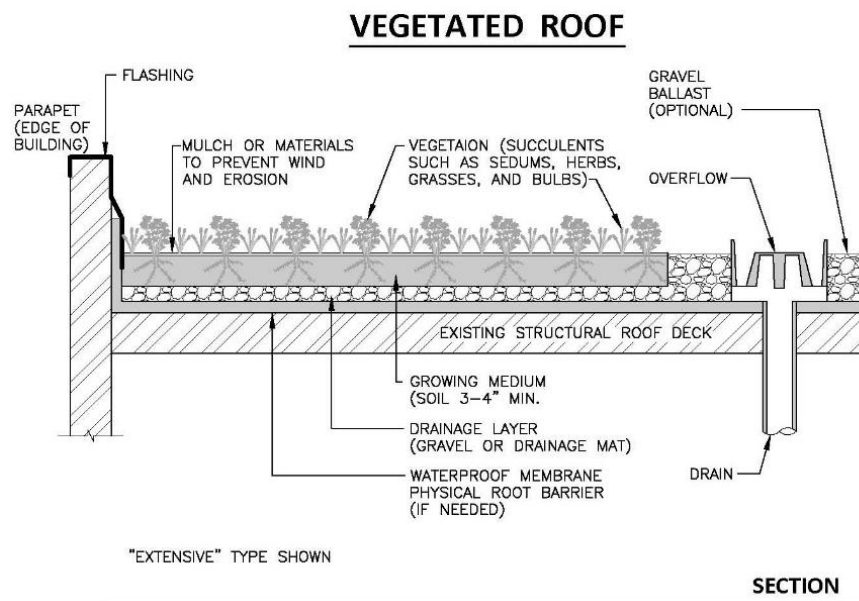



## O. Water Quality Device

### 1. Summary

Description:	Stormwater treatment unit.
Application:	Practical for small sites and drainage areas.
Types:	Oil and grit separator; Hydrodynamic separator.
Pretreatment Required:	No. This BMP can provide pretreatment and spill containment
Maintenance Plan:	Yes.
Calculation Credits:	
Volume Reduction:	None.
Rate Reduction:	None.
Water Quality:	Count volume routed through BMP.

### 2. Sizing Calculations

- a. Select water quality device unit/model based on manufacturer's recommendations.
- b. When the device is used to provide spill containment, the minimum spill containment volume shall be provided between the normal water level and the entrance of the outlet pipe to capture a slug pollutant load from an accidental spill of toxic materials.

### 3. Design Requirements

- a. Configuration
  - (1) The geometry of the water quality device shall promote the trapping of floatables and sediments.
  - (2) The water quality device shall be designed to prevent surcharging in pipes upstream of the device.
- b. Emergency Overflow
  - (1) A bypass overflow shall be designed to convey the 10-year peak discharge at a minimum without release of trapped sediments and pollutants.
  - (2) The outlet from the overflow shall not be submerged under normal conditions.

## P. Bioswale and Water Quality Swale

### 1. Summary

Description:	Bioswale: Vegetated swale designed to capture and treat stormwater within a dry storage layer beneath the base of the channel. Water Quality Swale: Lined swale designed to provide spill containment.
Application:	Bioswale: Linear projects or areas. Water Quality Swale: Small sites in lieu of a spill containment cell when a permanent pool is not desirable.
Types:	Dry swale; Swale with check dams.
Pretreatment Required:	No. This BMP can provide pretreatment and spill containment.
Maintenance Plan:	Yes.
Calculation Credits:	
Volume Reduction:	Bioswale: Count volume stored and infiltrated.
Rate Reduction:	Adjust time-of-concentration by dividing storage volume by 10-year peak flow rate.
Water Quality:	Bioswale: Count volume stored and infiltrated, or routed through filter. Water Quality Swale: Count volume routed through filter.

### 2. Sizing Calculations

- Size for pretreatment (refer to Part 4 section “Calculating Storage Volumes and Release Rates, Pretreatment”).
- The pretreatment volume is the volume of the voids within the filter media including any temporary surface storage volume to the elevation of the overflow, and including any permanent pool within the outlet structure.
- The spill containment volume is the storage volume between the normal water level in the filter and the entrance of the outlet pipe. The minimum spill containment volume shall be provided to capture a slug pollutant load from an accidental spill of toxic materials.
- Depth of surface ponding shall be no more than 2 feet and drain within 24 hours. The bottom area of the BMP shall be used as the infiltration area. For bioswales, use Equation 4.28 to calculate drain time. For water quality swales, use Equation 4.29 and **Table 14** from “Constructed Filter” to calculate drain time.
- The swale shall be designed to pass the 10-year peak discharge with a minimum of 6-inches of freeboard to the top of bank.
- Volume Behind Check Dam (if used with bioswale)

(1) Calculate the wedge shaped storage volume behind each check dam:

$$\text{Storage Volume (cubic feet)} = 0.5 \times \text{Length of Swale Impoundment Area per Check Dam (feet)} \times \text{Depth of Check Dam (feet)} \times [\text{Top Width of Check Dam (feet)} + \text{Bottom Width of Check Dam (feet)}] / 2$$

### 3. Design Requirements

- a. Siting
  - (1) All inlets shall enter the water quality swale unless the inlet collects stormwater exclusively from non-hotspot areas (i.e. office parking, courtyard, roof).
- b. Configuration
  - (1) The bottom of the water quality swale shall be flat to encourage uniform ponding and filtration. Bioswales shall have a maximum longitudinal slope of 1%.
  - (2) The swale shall have a minimum bottom width of 2 feet and a maximum bottom width of 10 feet.
  - (3) Side slopes shall be 4:1 (H:V) or flatter.
  - (4) Sand filter shall have a minimum depth of 18 inches and a maximum depth of 36 inches.
  - (5) Stone bedding shall consist of at least 2 inches under the pipe and 4 inches above the pipe. An aggregate window extending to the filter surface may also be provided as a factor-of-safety.
  - (6) Underdrains shall have a 4-inch minimum pipe diameter.
  - (7) All underground pipes shall have clean-outs accessible from the surface.
  - (8) Pipes shall be sloped to prevent siltation.
- c. Check Dam Design
  - (1) Check dams may be used along bioswales to encourage ponding and infiltration.
  - (2) Check dams shall be earthen or other impervious design. Rock check dams are not suitable for infiltration.
  - (3) Maximum ponding depth behind check dams shall be 24 inches.
  - (4) Minimum top width of earthen check dam shall be 2 feet.
  - (5) Check dams shall be keyed into the bottom and sides of the swale a minimum of 1-foot on all sides. The height of the key must exceed the 10-year water surface elevation by a minimum of 6 inches on both sides.
  - (6) The center of the check dam crest must be below the sides of the check dam by a minimum of 12 inches.
  - (7) The crest of a downstream check dam shall be no lower than the downstream toe of the upstream check dam.
  - (8) Erosion control measures (i.e. riprap, turf reinforcement mat) shall be used to protect the integrity of the check dam and downstream toe.
- d. Inlet Design
  - (1) Inlet pipes shall require energy dissipation. Riprap protection or equivalent erosion control measures shall be used where the velocity exceeds 4 feet per second up to a maximum allowable design velocity of 8 feet per second.
- e. Outlet Design
  - (1) The containment structure in a water quality swale shall be constructed within a manhole and be designed to draw water from the central portion of the water column within the manhole to trap floatables and contain sediments in a minimum 3-foot sump.

## f. Emergency Overflow

- (1) A positive outlet for overflow shall be provided.
- (2) A catch basin and outlet pipe may be used to convey the 10-year peak discharge. In water quality swales this must be a separate structure, or chamber within the containment manhole to prevent the captured low-density fluids from becoming entrained in the water when surface inflow enters the structure.

## g. Materials

## (1) Top Dressing

- (a.) Native or imported permeable soil (sand and gravel); or where turf establishment is desired
  - (b.) 3-inches of compost tilled into the top 6-inches of native permeable soil (equivalent to a 9-inch homogenous mixture of 70% sand; 30% compost); or
  - (c.) 4-inches of sandy topsoil tilled into the top 6-inches of native permeable soil (equivalent to a 10-inch homogenous mixture with maximum 20% silts, 4% clay, and 80% to 92% sand).
  - (d.) The soil mix shall have a pH between 5.5 and 7.5.
  - (e.) Topsoil shall be sandy loam, loamy sand or loam per USDA Soil Textural Triangle with 20% to 50% fines by volume (silt and clay with <10% clay), and 2% to 8% organic matter by dry weight.
- (2) Stone bedding shall consist of clean, uniformly graded coarse aggregate.
  - (3) A woven geotextile fabric or 2-inch gravel choker course shall be placed between the sand and the stone bedding.
  - (4) The water quality swale shall be lined with impermeable materials extending up to the design high water elevation. A minimum 18-inch-thick clay layer, or an impermeable liner protected with a minimum 12-inches of soil cover are acceptable alternatives. Maximum allowable permeability shall be  $1 \times 10^{-7}$  centimeters per second as determined by the geotechnical consultant for clay placement, or manufacturer's certificate for liner products.

4. Design Schematics

**BIOSWALE**

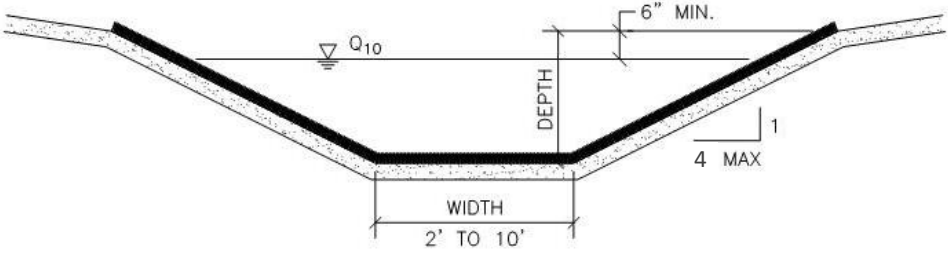

**SECTION**

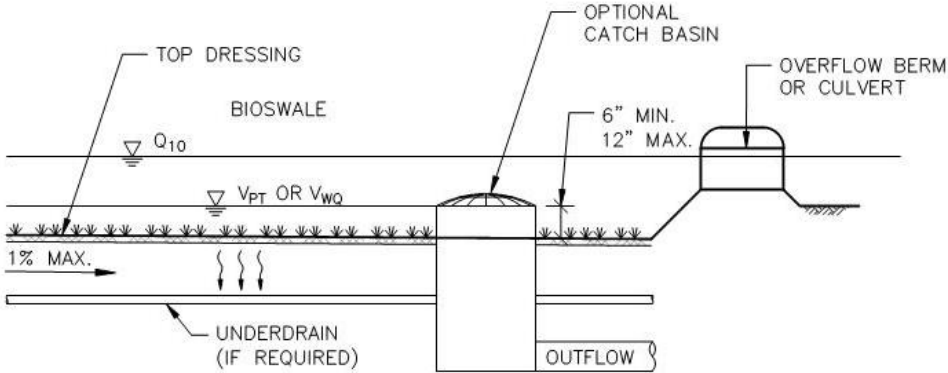

**PROFILE**

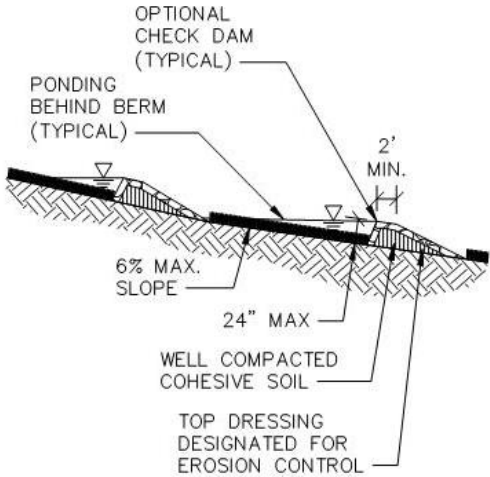

**CHECK DAM PROFILE**

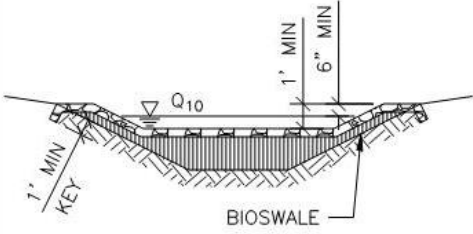

**CHECK DAM DETAIL**

### WATER QUALITY SWALE

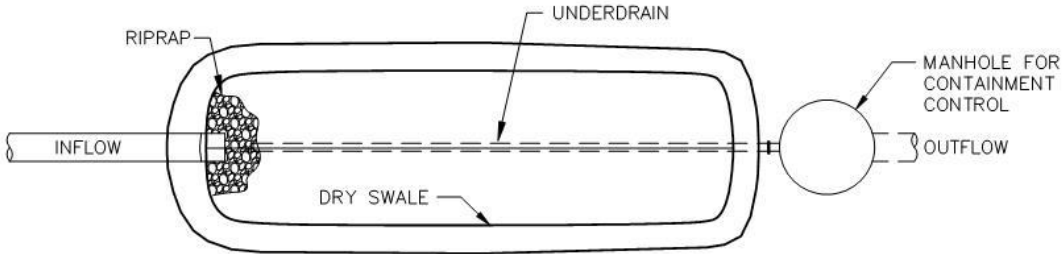

PLAN VIEW

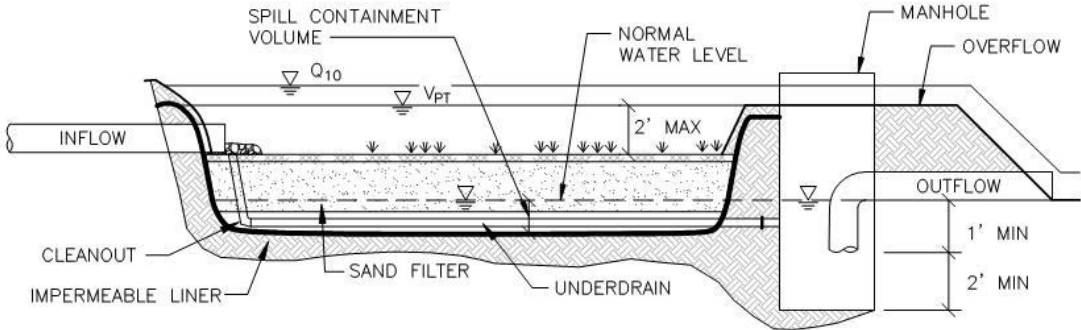

PROFILE

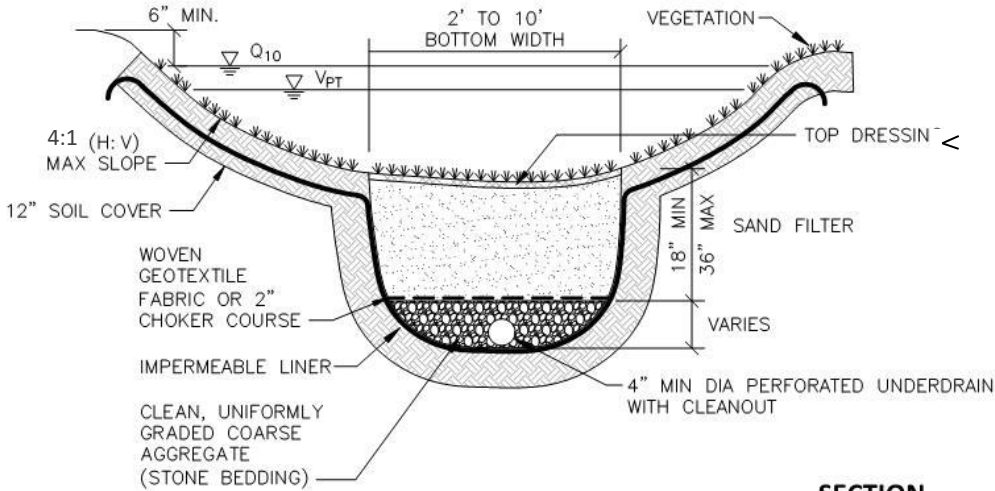

SECTION

## Q. Vegetated Swale

### 1. Summary

Description:	Stormwater conveyance designed to slow and filter stormwater.
Application:	Small drainage areas with concentrated flow, rear or side yard drainage.
Types:	Dry swale; Swale with check dams (no infiltration).
Pretreatment Required:	No. This BMP provides pretreatment.
Maintenance Plan:	Yes.
Calculation Credits:	
Volume Reduction:	None.
Rate Reduction:	Due to longer time-of-concentration for swale.
Water Quality:	Count volume routed through BMP.

### 2. Sizing Calculations

#### a. Channel

- (1) If used for pretreatment, refer to minimum standards in Part 3 section “Pretreatment.”
- (2) The vegetated swale shall be sized to pass the 10-year peak discharge with a minimum of 6 inches of freeboard to the top of bank.
- (3) Calculate 10-year peak flow rate (refer to Part 4 section “Calculating Runoff”).
- (4) Size swale using Manning’s Equation:

$$Q = \frac{1.49AR^{\frac{2}{3}}S^{\frac{1}{2}}}{n} \quad (4.23)$$

where:

- $Q$  = discharge (cubic feet per second)
- $A$  = wetted area (square feet)
- $R$  = hydraulic radius (feet)
- $S$  = slope (feet per foot)
- $n$  = Manning’s roughness coefficient

- (5) Select the higher value of Manning’s roughness coefficient from **Table 12** or **Figure 3** below.

**Figure 3 – Manning’s Roughness Coefficients for Vegetated Swales**

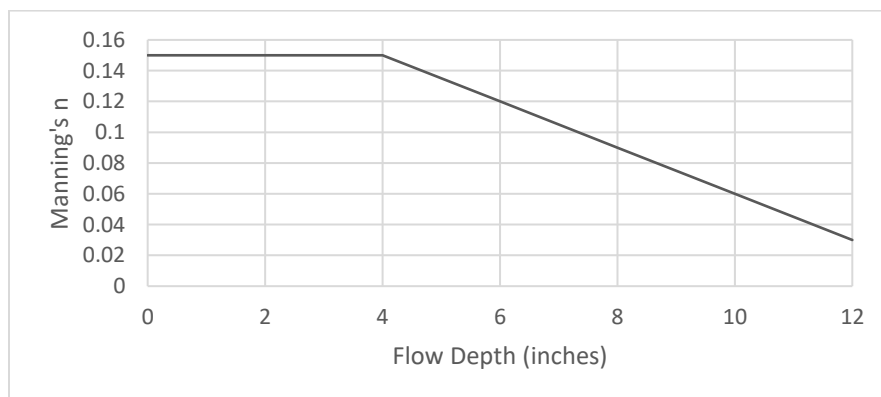

Source: SEMCOG (2008). *Low Impact Development Manual for Michigan*, Figure 7.62.

- (6) Check that flow velocities are within acceptable limits. The minimum velocity for open channels shall be 1.5 feet per second. The maximum velocity shall be 4 feet per second.

### 3. Design Requirements

#### a. Siting

- (1) Vegetated swales can be used for drainage areas up to 5 acres. Drainage areas greater than this may require open channels.
- (2) Minimum surface area to meet water quality standard by vegetative filtering:
  - (a.) The maximum bottom width to depth ratio for the water quality discharge shall be 12:1, or approximately equal to the grass height.
  - (b.) Minimum length per **Figures 4a** through **4d**.

#### b. Configuration

- (1) Trapezoidal, with a minimum bottom width of 2 feet and a maximum bottom width of 8 feet.
- (2) Side slopes shall be 4:1 (H:V) or flatter.
- (3) Longitudinal slope shall be a minimum of 1% and a maximum of 6%. Flatter slopes may be allowed on permeable soils.
- (4) If vegetated or drainage swales are used for rear or side yard drainage, underdrains may be required.

#### c. Check Dam Design

- (1) Check dams may be used for energy dissipation along vegetated swales with longitudinal slopes greater than 3%.
- (2) Maximum ponding depth behind check dams shall be 18 inches.
- (3) Check dams shall be keyed into the bottom and sides of the swale a minimum of 1-foot on all sides. The height of the key must exceed the 10-year water surface elevation by a minimum of 6 inches on both sides.
- (4) The center of the check dam crest must be below the sides of the check dam by a minimum of 12 inches.
- (5) The crest of a downstream check dam shall be no lower than the downstream toe of the upstream check dam.

#### d. Materials

- (1) Establishment of vegetation shall follow the guidelines outlined in **Table 15**.

**Table 15 – Permanent Stabilization Treatment for Vegetated Swales**

Swale Bottom Treatment	Swale Grade
Seed and Mulch	0.3% to 0.5%
Standard Mulch Blanket	0.5% to 1.5%
High Velocity Mulch Blanket or Sod	1.5% to 3.0%
Turf Reinforcement Mat or Check Dams	3.0% to 6.0%
Specific Design Required	> 6.0%

Source: *Michigan Department of Transportation Drainage Manual (2006)*.



4. Design Schematics

**VEGETATED SWALE**

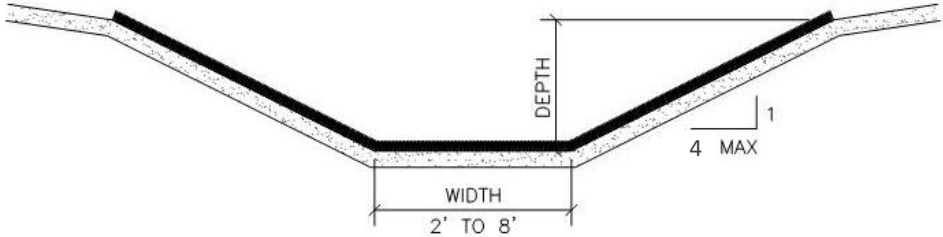

**SECTION**

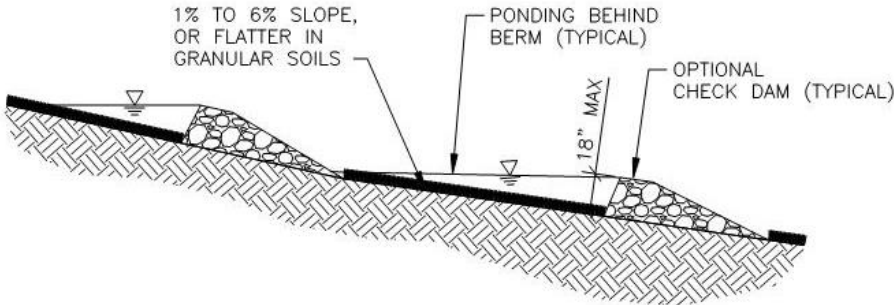

**PROFILE**

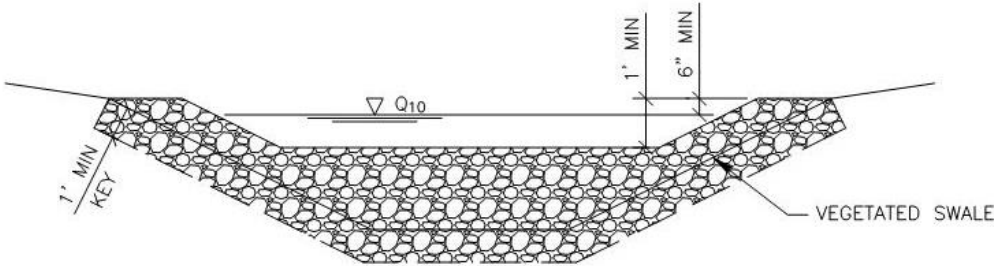

**CHECK DAM DETAIL**

## R. Vegetated Filter Strip

### 1. Summary

Description:	Overland flow path designed to slow and filter stormwater.
Application:	Contributing drainage areas with sheet flow surface runoff.
Types:	Turf grass; other dense herbaceous groundcover vegetation.
Pretreatment Required:	No. This BMP provides pretreatment.
Maintenance Plan:	Yes.
Calculation Credits:	
Volume Reduction:	None.
Rate Reduction:	Adjust time-of-concentration.
Water Quality:	Count volume routed through BMP.

### 2. Sizing Calculations

- a. If used for pretreatment, refer to minimum standards in Part 3 section “Pretreatment.”
- b. Calculate the minimum required filter strip area by the equation:

$$A_{fs} = \frac{A}{6} \quad (4.31)$$

where:

$A_{fs}$  = area of filter strip (square feet)

$A$  = contributing drainage area (square feet)

*Note:* This equates to a loading ratio of 0.17 from the contributing drainage area (both impervious and pervious surfaces).

- c. Calculate minimum required longitudinal length based on slope and type of vegetation using the graphs in **Figures 4a** through **4d**.

### 3. Design Requirements

- a. Siting
  - (1) Maximum upstream drainage area shall generally be 100 feet impervious or 200 feet pervious upgradient.
- b. Configuration
  - (1) The upstream edge of the filter strip shall be level and at an elevation at least 1 inch below the adjacent pavement.
  - (2) A level spreader may also be required to evenly distribute flow across filter strip.
  - (3) Slopes shall range from a minimum of 1% to a maximum of 8%. Optimal slopes range from 2% to 6%.
  - (4) The maximum lateral slope shall be 1%.
  - (5) Berms and curbs may be installed along the sides of the filter strip parallel to the direction of flow to prohibit runoff from laterally bypassing the filter strip.

Figure 4a – Filter Strip Length (Sandy soils with HSG A)

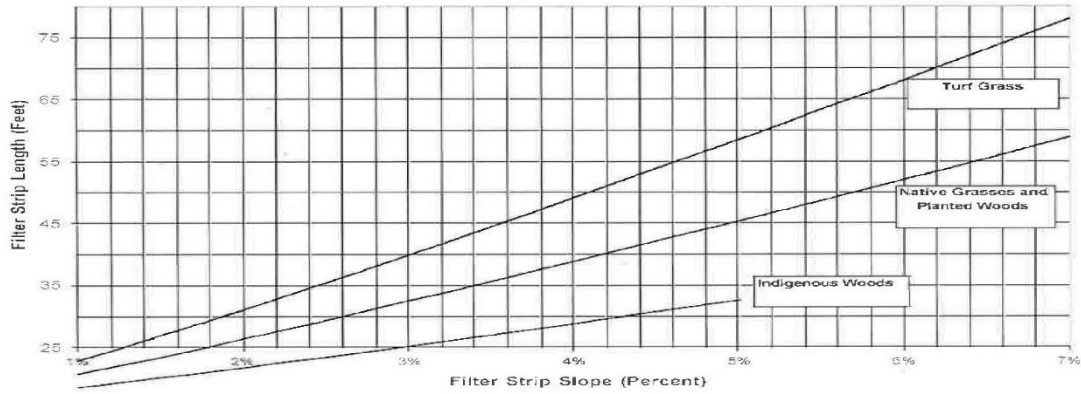

Figure 4b1 – Filter Strip Length (Sandy Loam soils with HSG B)

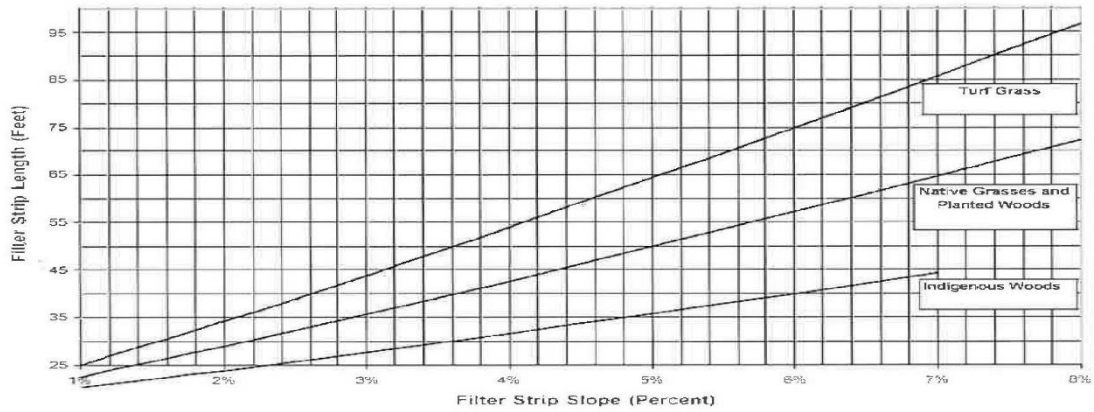
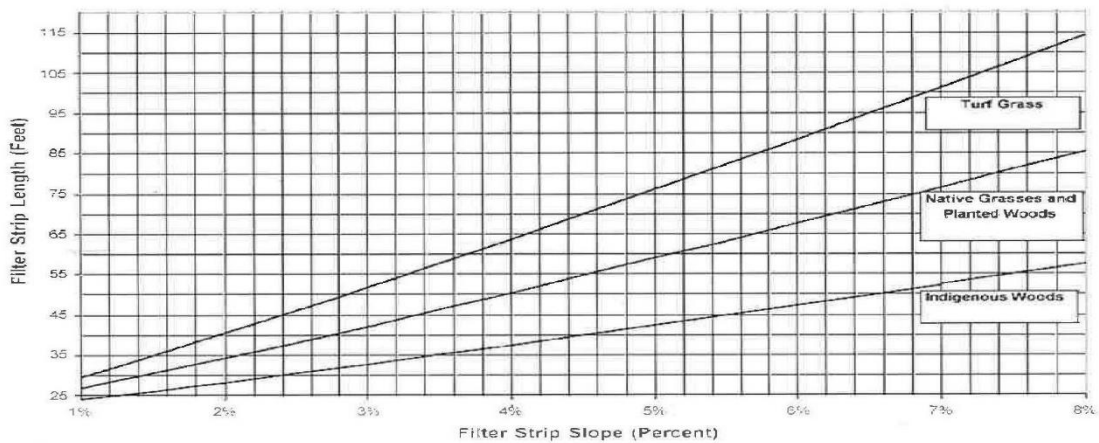

Figure 4b2 – Filter Strip Length (Loam, Silt-Loam soils with HSG B)



Source: SEMCOG (2008), *Low Impact Development Manual for Michigan*, Figures 7.52, 7.53 and 7.54 (New Jersey Stormwater Best Management Practices Manual, 2004)

Figure 4c – Filter Strip Length (Sandy Clay Loam soils with HSG C)

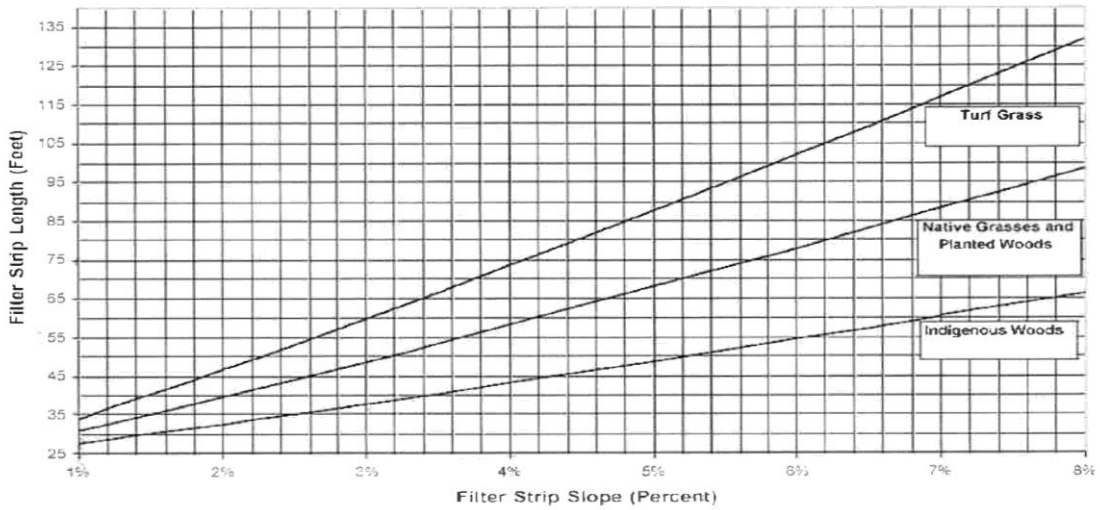
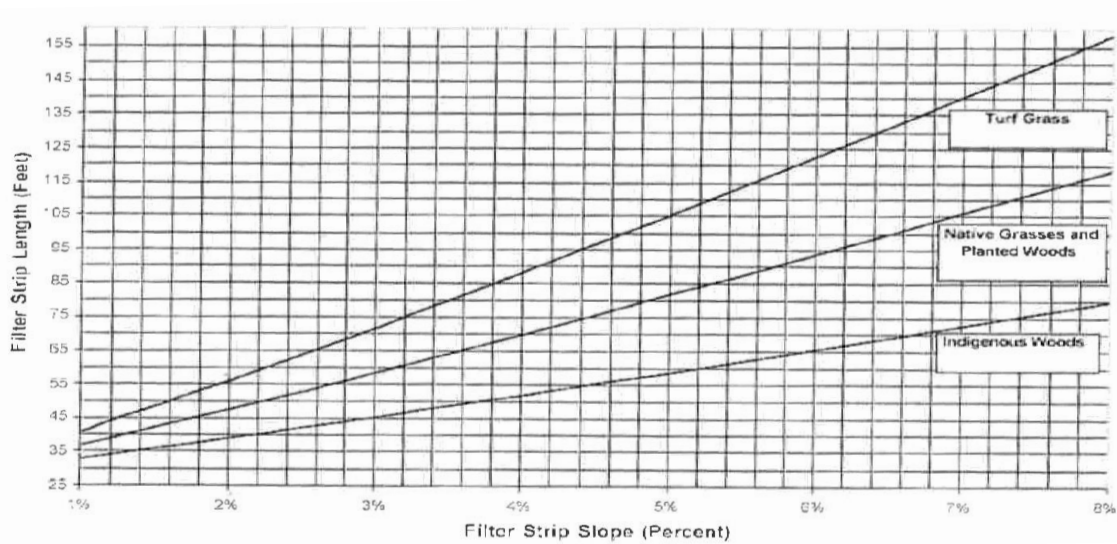

Figure 4d – Filter Strip Length (Clay Loam, Silty Clay, Clay soils with HSG D)



Source: SEMCOG (2008), *Low Impact Development Manual for Michigan*, Figures 7.55 and 7.56 (New Jersey Stormwater Best Management Practices Manual, 2004)

4. Design Schematics

**VEGETATED FILTER STRIP**

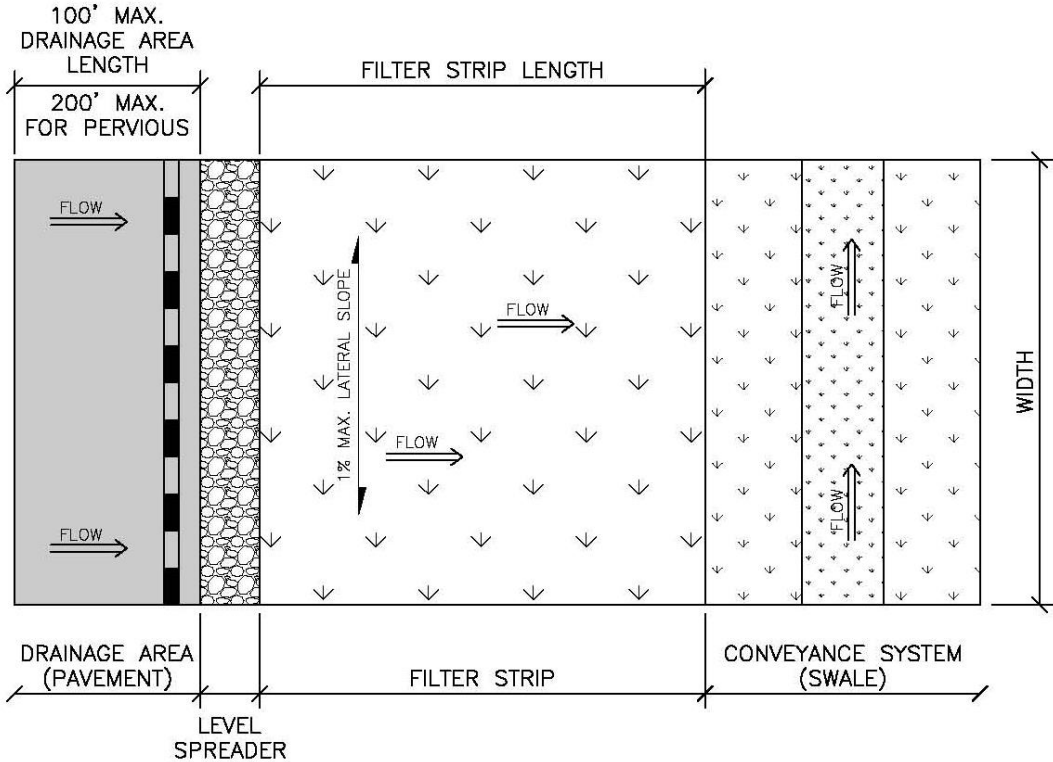

MIN. FILTER STRIP AREA = 1/6 DRAINAGE AREA.

**PLAN VIEW**

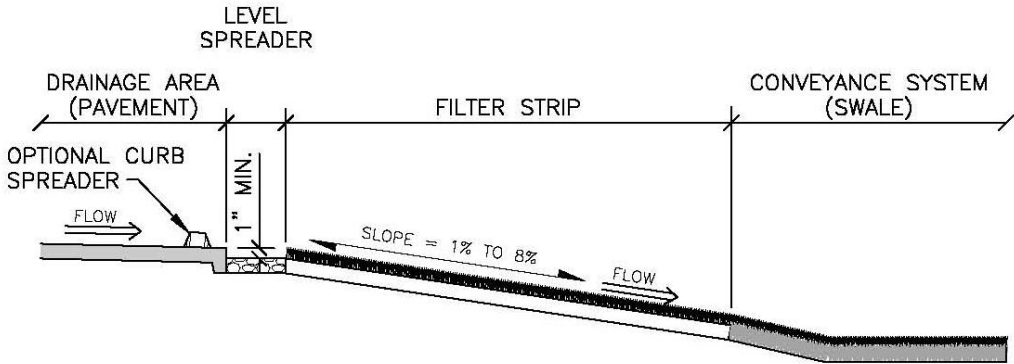

**PROFILE**

## S. Level Spreader

### 1. Summary

Description:	Shallow, level berm placed perpendicular to a flow path.
Application:	Used with other BMPs to disperse concentrated stormwater flows.
Types:	Inflow (prior to BMP); Outflow (at outlet of BMP).
Pretreatment Required:	No. This BMP provides pretreatment.
Maintenance Plan:	Yes.
Calculation Credits:	
Volume Reduction:	None.
Rate Reduction:	None.
Water Quality:	None.

### 2. Sizing Calculations

- a. The level spreader shall be sized to pass the 10-year peak flow.
- b. Calculate 10-year peak flow rate (refer to Part 4 section “Calculating Runoff”).

### 3. Design Requirements

- a. Siting
  - (1) Slopes below outflow level spreaders should be no greater than 8% in the direction of flow to discourage channelization.
- b. Configuration
  - (1) Construct level spreaders in compacted fill or of other non-erodible material.
  - (2) Minimum length: 10 feet.
  - (3) A bypass may be required for higher flows.
- c. Material
  - (1) Level spreaders may be constructed of compacted earth, rock, stone, concrete, treated timber or perforated pipe in stone.